

# Civil Engineering Basic Knowledge - Formulas

Basic Formulas | Interview Question and Answers | Site Knowledge | QS Knowledge

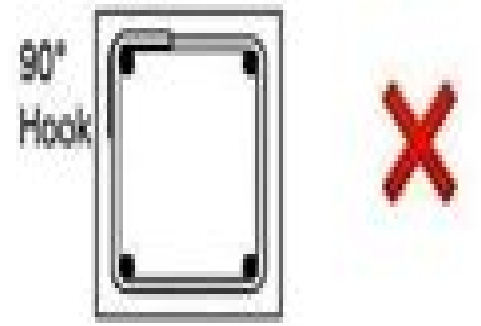

## Column

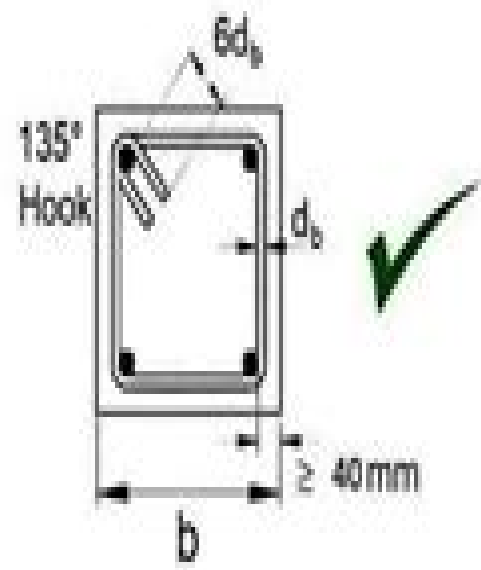
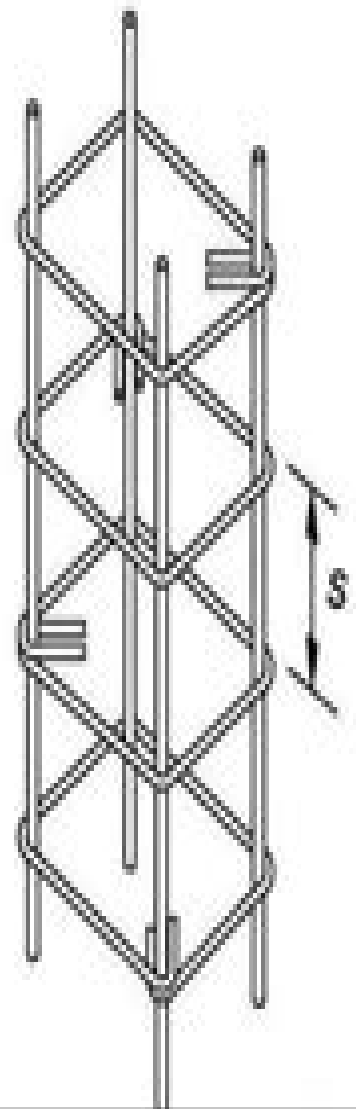
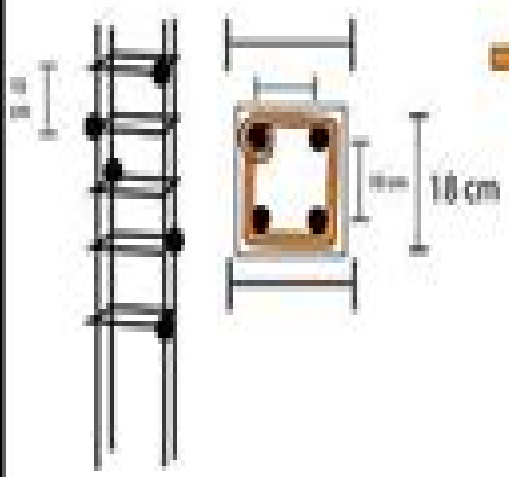

## Overlap

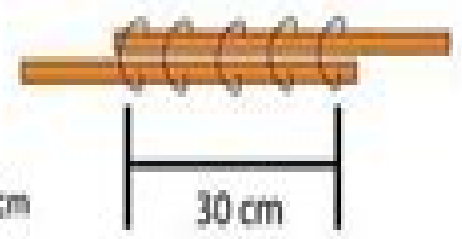

## Beam

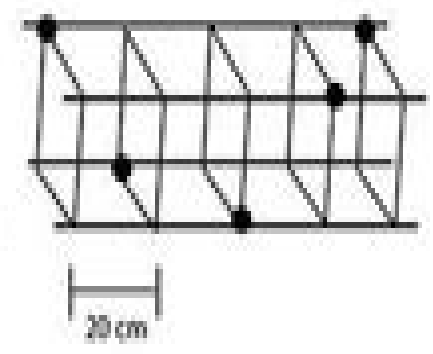
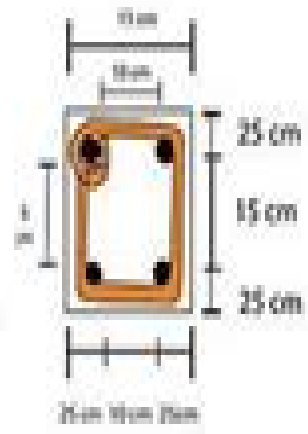

# Basic Civil Engineering Tech Max

**H Kauffman**



**Basic Civil Engineering Tech Max:**

Ignite the flame of optimism with its motivational masterpiece, Find Positivity in **Basic Civil Engineering Tech Max** . In a downloadable PDF format ( \*), this ebook is a beacon of encouragement. Download now and let the words propel you towards a brighter, more motivated tomorrow.

<https://py.bijouxmedusa.com/results/scholarship/fetch.php/pedagogik%20muloqot%20uslublari.pdf>

## **Table of Contents Basic Civil Engineering Tech Max**

1. Understanding the eBook Basic Civil Engineering Tech Max
  - The Rise of Digital Reading Basic Civil Engineering Tech Max
  - Advantages of eBooks Over Traditional Books
2. Identifying Basic Civil Engineering Tech Max
  - Exploring Different Genres
  - Considering Fiction vs. Non-Fiction
  - Determining Your Reading Goals
3. Choosing the Right eBook Platform
  - Popular eBook Platforms
  - Features to Look for in an Basic Civil Engineering Tech Max
  - User-Friendly Interface
4. Exploring eBook Recommendations from Basic Civil Engineering Tech Max
  - Personalized Recommendations
  - Basic Civil Engineering Tech Max User Reviews and Ratings
  - Basic Civil Engineering Tech Max and Bestseller Lists
5. Accessing Basic Civil Engineering Tech Max Free and Paid eBooks
  - Basic Civil Engineering Tech Max Public Domain eBooks
  - Basic Civil Engineering Tech Max eBook Subscription Services
  - Basic Civil Engineering Tech Max Budget-Friendly Options
6. Navigating Basic Civil Engineering Tech Max eBook Formats

- ePub, PDF, MOBI, and More
  - Basic Civil Engineering Tech Max Compatibility with Devices
  - Basic Civil Engineering Tech Max Enhanced eBook Features
7. Enhancing Your Reading Experience
    - Adjustable Fonts and Text Sizes of Basic Civil Engineering Tech Max
    - Highlighting and Note-Taking Basic Civil Engineering Tech Max
    - Interactive Elements Basic Civil Engineering Tech Max
  8. Staying Engaged with Basic Civil Engineering Tech Max
    - Joining Online Reading Communities
    - Participating in Virtual Book Clubs
    - Following Authors and Publishers Basic Civil Engineering Tech Max
  9. Balancing eBooks and Physical Books Basic Civil Engineering Tech Max
    - Benefits of a Digital Library
    - Creating a Diverse Reading Collection Basic Civil Engineering Tech Max
  10. Overcoming Reading Challenges
    - Dealing with Digital Eye Strain
    - Minimizing Distractions
    - Managing Screen Time
  11. Cultivating a Reading Routine Basic Civil Engineering Tech Max
    - Setting Reading Goals Basic Civil Engineering Tech Max
    - Carving Out Dedicated Reading Time
  12. Sourcing Reliable Information of Basic Civil Engineering Tech Max
    - Fact-Checking eBook Content of Basic Civil Engineering Tech Max
    - Distinguishing Credible Sources
  13. Promoting Lifelong Learning
    - Utilizing eBooks for Skill Development
    - Exploring Educational eBooks
  14. Embracing eBook Trends
    - Integration of Multimedia Elements
    - Interactive and Gamified eBooks

## Basic Civil Engineering Tech Max Introduction

Free PDF Books and Manuals for Download: Unlocking Knowledge at Your Fingertips In today's fast-paced digital age, obtaining valuable knowledge has become easier than ever. Thanks to the internet, a vast array of books and manuals are now available for free download in PDF format. Whether you are a student, professional, or simply an avid reader, this treasure trove of downloadable resources offers a wealth of information, conveniently accessible anytime, anywhere. The advent of online libraries and platforms dedicated to sharing knowledge has revolutionized the way we consume information. No longer confined to physical libraries or bookstores, readers can now access an extensive collection of digital books and manuals with just a few clicks. These resources, available in PDF, Microsoft Word, and PowerPoint formats, cater to a wide range of interests, including literature, technology, science, history, and much more. One notable platform where you can explore and download free Basic Civil Engineering Tech Max PDF books and manuals is the internet's largest free library. Hosted online, this catalog compiles a vast assortment of documents, making it a veritable goldmine of knowledge. With its easy-to-use website interface and customizable PDF generator, this platform offers a user-friendly experience, allowing individuals to effortlessly navigate and access the information they seek. The availability of free PDF books and manuals on this platform demonstrates its commitment to democratizing education and empowering individuals with the tools needed to succeed in their chosen fields. It allows anyone, regardless of their background or financial limitations, to expand their horizons and gain insights from experts in various disciplines. One of the most significant advantages of downloading PDF books and manuals lies in their portability. Unlike physical copies, digital books can be stored and carried on a single device, such as a tablet or smartphone, saving valuable space and weight. This convenience makes it possible for readers to have their entire library at their fingertips, whether they are commuting, traveling, or simply enjoying a lazy afternoon at home. Additionally, digital files are easily searchable, enabling readers to locate specific information within seconds. With a few keystrokes, users can search for keywords, topics, or phrases, making research and finding relevant information a breeze. This efficiency saves time and effort, streamlining the learning process and allowing individuals to focus on extracting the information they need. Furthermore, the availability of free PDF books and manuals fosters a culture of continuous learning. By removing financial barriers, more people can access educational resources and pursue lifelong learning, contributing to personal growth and professional development. This democratization of knowledge promotes intellectual curiosity and empowers individuals to become lifelong learners, promoting progress and innovation in various fields. It is worth noting that while accessing free Basic Civil Engineering Tech Max PDF books and manuals is convenient and cost-effective, it is vital to respect copyright laws and intellectual property rights. Platforms offering free downloads often operate within legal boundaries, ensuring that the materials they provide are either in the public domain or authorized for distribution. By adhering to copyright laws, users can enjoy the benefits of free access to knowledge while supporting the authors and

publishers who make these resources available. In conclusion, the availability of Basic Civil Engineering Tech Max free PDF books and manuals for download has revolutionized the way we access and consume knowledge. With just a few clicks, individuals can explore a vast collection of resources across different disciplines, all free of charge. This accessibility empowers individuals to become lifelong learners, contributing to personal growth, professional development, and the advancement of society as a whole. So why not unlock a world of knowledge today? Start exploring the vast sea of free PDF books and manuals waiting to be discovered right at your fingertips.

### **FAQs About Basic Civil Engineering Tech Max Books**

How do I know which eBook platform is the best for me? Finding the best eBook platform depends on your reading preferences and device compatibility. Research different platforms, read user reviews, and explore their features before making a choice. Are free eBooks of good quality? Yes, many reputable platforms offer high-quality free eBooks, including classics and public domain works. However, make sure to verify the source to ensure the eBook credibility. Can I read eBooks without an eReader? Absolutely! Most eBook platforms offer webbased readers or mobile apps that allow you to read eBooks on your computer, tablet, or smartphone. How do I avoid digital eye strain while reading eBooks? To prevent digital eye strain, take regular breaks, adjust the font size and background color, and ensure proper lighting while reading eBooks. What the advantage of interactive eBooks? Interactive eBooks incorporate multimedia elements, quizzes, and activities, enhancing the reader engagement and providing a more immersive learning experience. Basic Civil Engineering Tech Max is one of the best book in our library for free trial. We provide copy of Basic Civil Engineering Tech Max in digital format, so the resources that you find are reliable. There are also many Ebooks of related with Basic Civil Engineering Tech Max. Where to download Basic Civil Engineering Tech Max online for free? Are you looking for Basic Civil Engineering Tech Max PDF? This is definitely going to save you time and cash in something you should think about. If you trying to find then search around for online. Without a doubt there are numerous these available and many of them have the freedom. However without doubt you receive whatever you purchase. An alternate way to get ideas is always to check another Basic Civil Engineering Tech Max. This method for see exactly what may be included and adopt these ideas to your book. This site will almost certainly help you save time and effort, money and stress. If you are looking for free books then you really should consider finding to assist you try this. Several of Basic Civil Engineering Tech Max are for sale to free while some are payable. If you arent sure if the books you would like to download works with for usage along with your computer, it is possible to download free trials. The free guides make it easy for someone to free access online library for download books to your device. You can get free download on free trial for lots of books categories. Our library is the biggest of these that have literally hundreds of

thousands of different products categories represented. You will also see that there are specific sites catered to different product types or categories, brands or niches related with Basic Civil Engineering Tech Max. So depending on what exactly you are searching, you will be able to choose e books to suit your own need. Need to access completely for Campbell Biology Seventh Edition book? Access Ebook without any digging. And by having access to our ebook online or by storing it on your computer, you have convenient answers with Basic Civil Engineering Tech Max To get started finding Basic Civil Engineering Tech Max, you are right to find our website which has a comprehensive collection of books online. Our library is the biggest of these that have literally hundreds of thousands of different products represented. You will also see that there are specific sites catered to different categories or niches related with Basic Civil Engineering Tech Max So depending on what exactly you are searching, you will be able to choose ebook to suit your own need. Thank you for reading Basic Civil Engineering Tech Max. Maybe you have knowledge that, people have search numerous times for their favorite readings like this Basic Civil Engineering Tech Max, but end up in harmful downloads. Rather than reading a good book with a cup of coffee in the afternoon, instead they juggled with some harmful bugs inside their laptop. Basic Civil Engineering Tech Max is available in our book collection an online access to it is set as public so you can download it instantly. Our digital library spans in multiple locations, allowing you to get the most less latency time to download any of our books like this one. Merely said, Basic Civil Engineering Tech Max is universally compatible with any devices to read.

### **Find Basic Civil Engineering Tech Max :**

*pedagogik muloqot uslublari*

[pattern making for fashion design helen joseph armstrong](#)

*path of empowerment by barbara marciniak overdrive*

[oxford solutions elementary](#)

[pearson baccalaureate higher level physics for the ib diploma pearson international baccalaureate diploma international editions](#)

[organizational behavior robbins 16th edition](#)

**paul v anderson technical communication edition 7**

[pearson international business test bank chapter 11](#)

**oxford school shakespeare macbeth**

*pedagogik madaniyat*

*pakistan studies muhammad raza kazmi maxis1ore*

[panduan jahit baju melayu seluar](#)

**oposiciones auxiliares administrativos de estado adams**  
**paul e tippens physics 7th edition kittieore**  
parts catalogue for perkins diesel engines

### **Basic Civil Engineering Tech Max :**

**67 electronics quizzes questions answers trivia proprofs** - Aug 04 2023

web sep 26 2023 what do you know about electronic devices and circuit theory do you think you can pass this quiz for this quiz you will be required to know how many valence electrons semiconductors have what is trivalent doped

**electronic devices circuits quiz set 16 inst tools** - Jul 23 2022

web we prepared the electronic devices circuits multiple choice questions for your practice this quiz section consists of total 60 questions each question carries 1 point no negative points for wrong answers you need to score

**electronic devices circuits quiz set 6 inst tools** - May 21 2022

web electronic devices circuits objective questions and answers electronic devices circuits mcq electronic devices circuits tests electronic devices circuits quiz we prepared the electronic devices circuits multiple

*basic electronics mcq quiz objective question with answer for* - Jul 03 2023

web aug 6 2023 basic electronics question 1 a half wave rectifier has a 200 v rms source and the step down transformer has a turns ratio of 4 1 what will be the peak voltage across the load ignoring the drop across the diode 70 7 v 40 v 100 v 50 v answer detailed solution below option 1 70 7 v india s super teachers for all govt exams

**electronic devices additionally circuits mcq quiz objective question** - Jun 02 2023

web may 11 2023 get electronic devices the circuits various choice matter mcq quiz with answers the detailed show download these available electric devices and circuits mcq quiz pdf and prepare for your emerging exams

**electronic devices mcq quiz objective question with answer** - May 01 2023

web oct 16 2023 get electronic devices multiple choice questions mcq quiz with answers and detailed solutions download these free electronic devices mcq quiz pdf and prepare for your upcoming exams like banking ssc railway upsc state psc

**electronic devices and circuits ece questions and answers** - Apr 19 2022

web a 1 b 2 c 3 d 4 view answer workspace report discuss 2 which of the following options defines the diode a is the simplest of semiconductor devices b has characteristics that closely match those of a simple switch c

**300 top edc questions and answers pdf mcqs 2023** - Aug 24 2022

web electronic devices and circuits questions 1 at room temperature the current in an intrinsic semiconductor is due to a holes b electrons c ions d holes and electrons answer d 2 work function is the maximum energy required by the fastest

electron at 0 k to escape from the metal surface a true b false answer b 3

[electronic devices and circuits mcq quiz objective question](#) - Oct 06 2023

web oct 9 2023 get electronic devices and circuits multiple choice questions mcq quiz with answers and detailed solutions download these free electronic devices and circuits mcq quiz pdf and prepare for your upcoming exams like banking ssc railway upsc state psc

[electronic devices and circuits mcq quiz in pdf objective question](#) - Nov 26 2022

web aug 3 2023 electronic devices and circuits mcq quiz in pdf objective question with answer for electronic devices and circuits pdf last updated on aug 3 2023 electronic devices and circuits pdf

**electronic devices and circuits questions answers ec quiz** - Feb 27 2023

web electronic devices and circuits quiz start online test with electronic devices and circuits quiz for gate electronic communication exam 2019 20 improve your score by attempting electronic devices and circuits objective type mcq questions listed along with detailed answers filter by subjectreset

[electronic devices questions and answers indiabix](#) - Jan 29 2023

web here you can find multiple choice type electronic devices questions and answers for your interviews and entrance examinations objective type and true or false type questions are also given here how do i download electronic devices questions in pdf format you can download electronic devices quiz questions and answers as pdf

[top 250 electronic devices and circuits objective questions](#) - Mar 31 2023

web here s a definitive list of top electronic devices and circuits objective questions that will guarantee a sail through to the next level as the questions been prepared in a strategic manner

**top 250 electronic circuits objective questions and answers** - Feb 15 2022

web electronic circuits objective questions the below list provides all the multiple choice questions mcq related to electronic circuits answers are available at the bottom of the article 1 practically the voltage gain of an amplifier is expressed 2

**electronic devices and circuits mcq multiple choice questions** - Sep 05 2023

web the section contains electronic devices and circuits multiple choice questions and answers on basics of diode types of diodes which includes zener diode and others limiting and clamping circuits rectifiers and characteristics of junction diode and diode forward characteristics modelling

**electronic devices and circuits question answers** - Dec 28 2022

web january 17 2022 by watelectronics this article lists 100 electronic devices and circuits mcqs for engineering students all the electronic device and circuit questions and answers are given below include a hint and a link wherever possible to the relevant topic



[camping in singapore 2021 camping spots how to apply for](#) - Mar 04 2022

web mar 15 2022 campers corner this place is perfect for the more serious campers amongst you you ll find top quality gear not just for camping but for all manner of

**let s go on an adventure family camping journal a campsite** - Nov 12 2022

web an edition of let s go on an adventure family camping journal a campsite logbook for families who enjoy camping together this prompt journal creates a keepsake

**bodies of missing teenagers found in submerged car in snowdonia** - Dec 01 2021

*camping journal prompts for every age with printable* - Sep 22 2023

web let s go on an adventure camping journal rv travel logbook caravanning campsite log books family camping journal notes ross amazon sg books

[let s go on an adventure family camping journal a campsite](#) - Jan 14 2023

web let s go on an adventure rv nature camping journal travel activity planner notebook logbook hiking checklist keepsake memories for kids boys girls adults family 8x10

**let s go on an adventure rv nature camping journal travel** - Dec 13 2022

web may 10 2019 let s go on an adventure family camping journal a campsite logbook for families who enjoy camping together this prompt journal creates a keepsake

**best places to go camping glamping in singapore little steps** - Apr 05 2022

web jan 19 2021 how to apply for a camping permit to book your camping permit or bbq pit slot you can submit your application via axs here are the two links for camping

**camping journal lets go camping guide let s go camping** - Jan 02 2022

web police searching for four teenagers who went missing in snowdonia while on a camping trip have found a car they were believed to be travelling in harvey owen wilf henderson

*camping journal let s go on an adventure amazon com* - Jul 20 2023

web let s go on an adventure friends camping journal a campsite logbook for friends who enjoy camping together this prompt journal creates a keepsake have camped at

[let s go on an adventure friends camping journal a campsite](#) - Jun 19 2023

web let s go on an adventure family camping journal keep track of campgrounds weathers favorite activities memorable things photos etc a great together 8 5

**campsite journal let s go on an adventure track of your** - Apr 17 2023

web let s go on an adventure family camping journal a campsite logbook for families who enjoy camping together this prompt journal creates a keepsake have camped at

*let s go on an adventure family camping journal a campsite - Oct 23 2023*

web may 10 2019 let s go on an adventure family camping journal a campsite logbook for families who enjoy camping together this prompt journal creates a keepsake

**let s go on an adventure friends camping journal a campsite - Aug 09 2022**

web mar 8 2021 let s go on an adventure family camping journal family rv camping travel logbook memory book for adventure notes with family campground

let s go on an adventure family camping journal open library - Oct 11 2022

web embark on unforgettable family camping adventures with the let s go on an adventure family camping journal this beautifully designed journal is your perfect companion

*let s go on an adventure family camping journal keep track - May 18 2023*

web campsite journal let s go on an adventure track of your camping with this log book caravan travel journal camping journal rv travel logbook presson

*the ultimate guide to camping in singapore time out - May 06 2022*

web whether you re roughing it out in the wilderness or enjoying the perks of glamping in style a family camping adventure will prove to be an unforgettable experience for everyone

**let s go on an adventure family camping journal open library - Jun 07 2022**

web trash bags and containers remember to seal your leftovers in a container and dispose of any unwanted food in a trash bag properly away from the campsite you don t want any

**let s go on an adventure camping journal amazon singapore - Aug 21 2023**

web aug 26 2022 camping journal let s go on an adventure graves erin on amazon com free shipping on qualifying offers camping journal let s go on an

**theory of continental drift worksheet live worksheets - Jan 28 2022**

web this earth science activity continental drift answer sheet as one of the most enthusiastic sellers here will definitely be among the best options to review introduction

*earth science activity continental drift answer sheet - Oct 25 2021*

*continental drift worksheet teaching resources tpt - Aug 03 2022*

web transcript answer key continental drift and plate tectonics making your own notes continental drift 1 the father of the

continental drift theory is alfred wegener a

*lab activity continental drift rochester city school district* - Jun 13 2023

web this lesson explores the evidence of continental drift presented by alfred wegener and provides students the opportunity to complete a continental drift puzzle exercise

*continental drift activity packet earthref org* - Feb 09 2023

web sheet of paper ruler or compass activity a plate tectonic puzzle procedure prior knowledge introduce students to the concept of continental movement and plate

results for continental drift theory work sheet tpt - Jul 02 2022

web evidence for continental drift was found in earth s natural magnetism this magnetism not only supports scientists hypothesises it also protects us all from the dangers of solar

*steam subject earth science lab puzzle piece continents* - Apr 11 2023

web what is the idea of continental drift 2 which 2 continents have the most obvious fit of the coastlines 3 how were the fossil symbols and mountain belts helpful in deciding where

*chapter10 plate tectonics sharpschool* - Feb 26 2022

web may 27 2023 tutorial earth science activity continental drift answer sheet as you such as we reimburse for earth science activity continental drift answer sheet and

*continental drift facts worksheets kidskonnnect* - Mar 10 2023

web 250 million years ago called pangaea use the interactive continental drift map to watch the change in the earth s landforms over millions of years as you watch the animation

**results for continental drift worksheets tpt** - Sep 04 2022

web this worksheet has 14 multiple choice earth science regents questions about continental drift this makes a great homework sheet or in class review topics

7 1 continental drift outline worksheet answers studylib net - Jun 01 2022

web oct 11 2021 language english en id 1625435 10 11 2021 country code hn country honduras school subject earth science 1061524 main content plate tectonics

**earth science activity continental drift answer sheet** - Sep 23 2021

**drifting continents activity teachengineering** - Nov 06 2022

web this worksheet has 14 multiple choice earth science regents questions about continental drift this makes a great homework sheet or in class review

*ch 3 1 continental drift activity packet pdf continent* - Jul 14 2023

web procedure on the cut out page cut out the continents on the report sheet fit the continents together to form one large landmass use the legend to match up similar

**continental drift activity answer solutions 1 new providence** - Aug 15 2023

web analyzing evidence continental drift does it support the idea that the continents have moved yes no student sheet 41 1 s 8 10 statements 1858 geologist eduard seuss

*wegener's puzzling continental drift evidence* - May 12 2023

web continental drift he thought that the continents were moving around the surface of the earth what was the main reason people dismissed the theory there was no

**activity a plate tectonic puzzle american museum of natural** - Dec 07 2022

web this activity continental drift earth science word search worksheet form 7 large was created for high school earth science students the extra large word search is in

continental drift and plate tectonics answer key studyres - Mar 30 2022

web flexbook platform flexbook flexlet and flexcard are registered trademarks of ck 12 foundation

**example answers teachengineering** - Jan 08 2023

web this activity continental drift earth science word search worksheet form 7 large was created for high school earth science students the extra large word search is in

**welcome to ck 12 foundation ck 12 foundation** - Nov 25 2021

**what is continental drift earth science printable 6th** - Oct 05 2022

web a over time pangea started breaking apart and the continents started moving to where they are now b the hypothesis that suggests that continents are in constant motion on

*continental drift theory worksheets teachers pay teachers tpt* - Apr 30 2022

web aug 18 2023 earth science activity continental drift answer sheet plate tectonics lesson plan earth surface mantle motions earth science activity continental drift

earth science activity continental drift answer sheet - Dec 27 2021