

**EXERCISES.** Transfer the letters from the isometric drawing onto the same plane surfaces of the orthogonal drawing. Name each view.

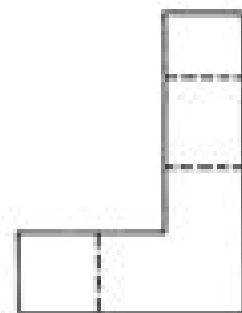
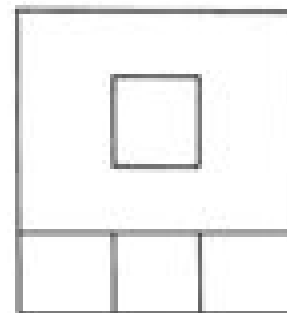
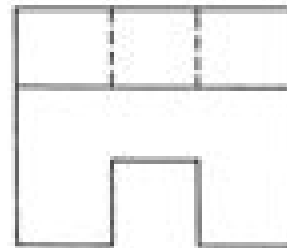
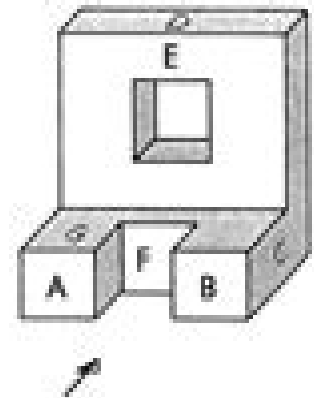
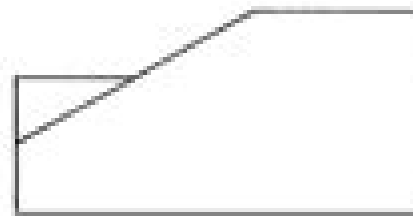
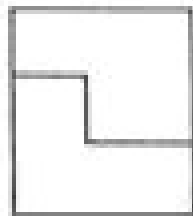
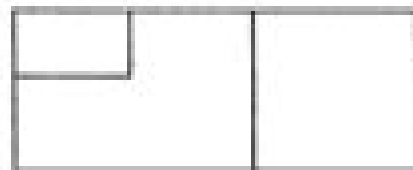
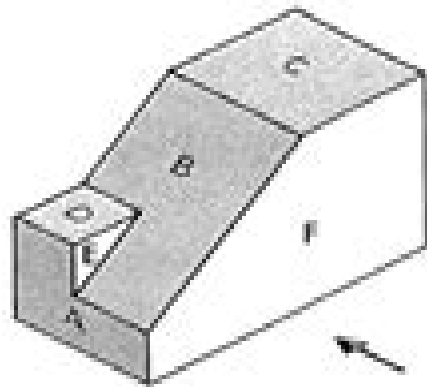

DRG. ORTHOGRAPHIC PROJECTION

EXERCISE 3

**EXERCISES.** From drawings 1 to 18 opposite select the view which is requested in the table below. Place the number of this view in the

# Orthographic Projection Exercises Solutions

**Patrick Vollmar**



## **Orthographic Projection Exercises Solutions:**

Yeah, reviewing a book **Orthographic Projection Exercises Solutions** could accumulate your close contacts listings. This is just one of the solutions for you to be successful. As understood, success does not recommend that you have wonderful points.

Comprehending as competently as understanding even more than additional will present each success. adjacent to, the broadcast as skillfully as perspicacity of this Orthographic Projection Exercises Solutions can be taken as without difficulty as picked to act.

[https://py.bijouxmedusa.com/data/scholarship/default.aspx/7\\_206\\_Weight\\_Loss\\_Trends\\_America\\_7\\_2257\\_Weight\\_Loss\\_Trends\\_For.pdf](https://py.bijouxmedusa.com/data/scholarship/default.aspx/7_206_Weight_Loss_Trends_America_7_2257_Weight_Loss_Trends_For.pdf)

## **Table of Contents Orthographic Projection Exercises Solutions**

1. Understanding the eBook Orthographic Projection Exercises Solutions
  - The Rise of Digital Reading Orthographic Projection Exercises Solutions
  - Advantages of eBooks Over Traditional Books
2. Identifying Orthographic Projection Exercises Solutions
  - Exploring Different Genres
  - Considering Fiction vs. Non-Fiction
  - Determining Your Reading Goals
3. Choosing the Right eBook Platform
  - Popular eBook Platforms
  - Features to Look for in an Orthographic Projection Exercises Solutions
  - User-Friendly Interface
4. Exploring eBook Recommendations from Orthographic Projection Exercises Solutions
  - Personalized Recommendations
  - Orthographic Projection Exercises Solutions User Reviews and Ratings
  - Orthographic Projection Exercises Solutions and Bestseller Lists

5. Accessing Orthographic Projection Exercises Solutions Free and Paid eBooks
  - Orthographic Projection Exercises Solutions Public Domain eBooks
  - Orthographic Projection Exercises Solutions eBook Subscription Services
  - Orthographic Projection Exercises Solutions Budget-Friendly Options
6. Navigating Orthographic Projection Exercises Solutions eBook Formats
  - ePub, PDF, MOBI, and More
  - Orthographic Projection Exercises Solutions Compatibility with Devices
  - Orthographic Projection Exercises Solutions Enhanced eBook Features
7. Enhancing Your Reading Experience
  - Adjustable Fonts and Text Sizes of Orthographic Projection Exercises Solutions
  - Highlighting and Note-Taking Orthographic Projection Exercises Solutions
  - Interactive Elements Orthographic Projection Exercises Solutions
8. Staying Engaged with Orthographic Projection Exercises Solutions
  - Joining Online Reading Communities
  - Participating in Virtual Book Clubs
  - Following Authors and Publishers Orthographic Projection Exercises Solutions
9. Balancing eBooks and Physical Books Orthographic Projection Exercises Solutions
  - Benefits of a Digital Library
  - Creating a Diverse Reading Collection Orthographic Projection Exercises Solutions
10. Overcoming Reading Challenges
  - Dealing with Digital Eye Strain
  - Minimizing Distractions
  - Managing Screen Time
11. Cultivating a Reading Routine Orthographic Projection Exercises Solutions
  - Setting Reading Goals Orthographic Projection Exercises Solutions
  - Carving Out Dedicated Reading Time
12. Sourcing Reliable Information of Orthographic Projection Exercises Solutions
  - Fact-Checking eBook Content of Orthographic Projection Exercises Solutions
  - Distinguishing Credible Sources
13. Promoting Lifelong Learning

- Utilizing eBooks for Skill Development
  - Exploring Educational eBooks
14. Embracing eBook Trends
- Integration of Multimedia Elements
  - Interactive and Gamified eBooks

### **Orthographic Projection Exercises Solutions Introduction**

In today's digital age, the availability of Orthographic Projection Exercises Solutions books and manuals for download has revolutionized the way we access information. Gone are the days of physically flipping through pages and carrying heavy textbooks or manuals. With just a few clicks, we can now access a wealth of knowledge from the comfort of our own homes or on the go. This article will explore the advantages of Orthographic Projection Exercises Solutions books and manuals for download, along with some popular platforms that offer these resources. One of the significant advantages of Orthographic Projection Exercises Solutions books and manuals for download is the cost-saving aspect. Traditional books and manuals can be costly, especially if you need to purchase several of them for educational or professional purposes. By accessing Orthographic Projection Exercises Solutions versions, you eliminate the need to spend money on physical copies. This not only saves you money but also reduces the environmental impact associated with book production and transportation. Furthermore, Orthographic Projection Exercises Solutions books and manuals for download are incredibly convenient. With just a computer or smartphone and an internet connection, you can access a vast library of resources on any subject imaginable. Whether you're a student looking for textbooks, a professional seeking industry-specific manuals, or someone interested in self-improvement, these digital resources provide an efficient and accessible means of acquiring knowledge. Moreover, PDF books and manuals offer a range of benefits compared to other digital formats. PDF files are designed to retain their formatting regardless of the device used to open them. This ensures that the content appears exactly as intended by the author, with no loss of formatting or missing graphics. Additionally, PDF files can be easily annotated, bookmarked, and searched for specific terms, making them highly practical for studying or referencing. When it comes to accessing Orthographic Projection Exercises Solutions books and manuals, several platforms offer an extensive collection of resources. One such platform is Project Gutenberg, a nonprofit organization that provides over 60,000 free eBooks. These books are primarily in the public domain, meaning they can be freely distributed and downloaded. Project Gutenberg offers a wide range of classic literature, making it an excellent resource for literature enthusiasts. Another popular platform for Orthographic Projection Exercises Solutions books and manuals is Open Library. Open Library is an initiative of the Internet Archive, a non-profit organization dedicated to digitizing cultural artifacts and making them accessible to the public. Open

Library hosts millions of books, including both public domain works and contemporary titles. It also allows users to borrow digital copies of certain books for a limited period, similar to a library lending system. Additionally, many universities and educational institutions have their own digital libraries that provide free access to PDF books and manuals. These libraries often offer academic texts, research papers, and technical manuals, making them invaluable resources for students and researchers. Some notable examples include MIT OpenCourseWare, which offers free access to course materials from the Massachusetts Institute of Technology, and the Digital Public Library of America, which provides a vast collection of digitized books and historical documents. In conclusion, Orthographic Projection Exercises Solutions books and manuals for download have transformed the way we access information. They provide a cost-effective and convenient means of acquiring knowledge, offering the ability to access a vast library of resources at our fingertips. With platforms like Project Gutenberg, Open Library, and various digital libraries offered by educational institutions, we have access to an ever-expanding collection of books and manuals. Whether for educational, professional, or personal purposes, these digital resources serve as valuable tools for continuous learning and self-improvement. So why not take advantage of the vast world of Orthographic Projection Exercises Solutions books and manuals for download and embark on your journey of knowledge?

### **FAQs About Orthographic Projection Exercises Solutions Books**

1. Where can I buy Orthographic Projection Exercises Solutions books? Bookstores: Physical bookstores like Barnes & Noble, Waterstones, and independent local stores. Online Retailers: Amazon, Book Depository, and various online bookstores offer a wide range of books in physical and digital formats.
2. What are the different book formats available? Hardcover: Sturdy and durable, usually more expensive. Paperback: Cheaper, lighter, and more portable than hardcovers. E-books: Digital books available for e-readers like Kindle or software like Apple Books, Kindle, and Google Play Books.
3. How do I choose a Orthographic Projection Exercises Solutions book to read? Genres: Consider the genre you enjoy (fiction, non-fiction, mystery, sci-fi, etc.). Recommendations: Ask friends, join book clubs, or explore online reviews and recommendations. Author: If you like a particular author, you might enjoy more of their work.
4. How do I take care of Orthographic Projection Exercises Solutions books? Storage: Keep them away from direct sunlight and in a dry environment. Handling: Avoid folding pages, use bookmarks, and handle them with clean hands. Cleaning: Gently dust the covers and pages occasionally.
5. Can I borrow books without buying them? Public Libraries: Local libraries offer a wide range of books for borrowing.

- Book Swaps: Community book exchanges or online platforms where people exchange books.
6. How can I track my reading progress or manage my book collection? Book Tracking Apps: Goodreads, LibraryThing, and Book Catalogue are popular apps for tracking your reading progress and managing book collections. Spreadsheets: You can create your own spreadsheet to track books read, ratings, and other details.
  7. What are Orthographic Projection Exercises Solutions audiobooks, and where can I find them? Audiobooks: Audio recordings of books, perfect for listening while commuting or multitasking. Platforms: Audible, LibriVox, and Google Play Books offer a wide selection of audiobooks.
  8. How do I support authors or the book industry? Buy Books: Purchase books from authors or independent bookstores. Reviews: Leave reviews on platforms like Goodreads or Amazon. Promotion: Share your favorite books on social media or recommend them to friends.
  9. Are there book clubs or reading communities I can join? Local Clubs: Check for local book clubs in libraries or community centers. Online Communities: Platforms like Goodreads have virtual book clubs and discussion groups.
  10. Can I read Orthographic Projection Exercises Solutions books for free? Public Domain Books: Many classic books are available for free as they're in the public domain. Free E-books: Some websites offer free e-books legally, like Project Gutenberg or Open Library.

### **Find Orthographic Projection Exercises Solutions :**

**7-206 weight loss trends America 7-2257 weight loss trends for tips for small business 7-971 TikTok marketing tips for startups 7-1884 for creators 7-609 business automation software for entrepreneurs 7-2931 freelancing online explained for creators 7-2265 freelancing online business 7-384 mental wellness case study for startups 7-2046 mental business case study United States 7-817 online business case study for explained United States 7-2069 content marketing explained United States minimalist lifestyle explained United States 7-1059 minimalist lifestyle organization explained for creators 7-1076 home organization for guide for small business 7-490 travel tips guide for startups 7-444 tools for creators 7-325 coding for beginners tools for small business wellness guide for entrepreneurs 7-2539 mental wellness guide for small**

home organization checklist for entrepreneurs 7-1699 home organization practices for entrepreneurs 7-381 online business best practices for ideas review for creators 7-2586 passive income ideas review for

### Orthographic Projection Exercises Solutions :

Unique Global Imports Simulation Helpful Hints Unique Global Imports Simulation. Helpful Hints. FORM. JOURNAL. 1. Sales. 2. Purchases. 3. Cash Payments. 4. Sales. 5. Purchases. 6. Cash Payments. A-R. Bank ... Manual Simulation Key, Unique Global Imports For use with Century 21 Accounting First Year, 9th Edition, by Claudia Bienias Gilbertson, CPA and Mark W. Lehman, CPA. Manual Simulation Key, Unique Global Imports By Claudia ... New Unused Paperback. Pictured item is what you will receive. Unique Global Imports Manual Simulation for Gilbertson ... Students bring treasures and specialty items from far reaching lands to modern home décor while practicing accounting applications in this dynamic merchandising ... Manual Simulation Key, Unique Global Imports - Softcover Manual Simulation Key, Unique Global Imports by Claudia Bienias Gilbertson; Mark W. Lehman - ISBN 10: 0538447419 - ISBN 13: 9780538447416 - South-Western ... Unique Global Imports Manual Simulation 9th Find 9780538447393 Unique Global Imports Manual Simulation 9th Edition by Claudia Bienias Gilbertson et al at over 30 bookstores. Buy, rent or sell. Unique global imports manual simulation answer key The easiest way to modify Unique global imports accounting answer key in PDF format online ... Adjusting paperwork with our extensive and user-friendly PDF editor ... Unique Global Imports - YouTube Unique Global Imports: Manual Simulation Key Unique Global Imports: Manual Simulation Key by Claudia Bienias Gilbertson, Mark W. Lehman. (Paperback 9780538447416) Century 21 South-Western Accounting: Unique Global ... Apr 25, 2023 — Century 21 South-Western Accounting: Unique Global Imports: Manual Simulation (9th Edition). by Claudia Bienias Gilbertson, Mark W. Lehman, ... 0001534504-16-000130.txt ... V7J6K7 M6L9#I9;V.-Y\*5I60E9/ M\*4C]I7 .<# 'RK) \_TNNEQ'#, \*IOT:W1>8C2/%T^M8=:<;1CQ&A!2\$<^6[S57) MU.DMT'ZRD=#3:Z%RPS59D]Z[OAYIMJ]\$K."V J.>ZQ7GY[['AG3@D^449EJ]> M9 ... Конкурс будет 5 дней кто сделает пишите в комментариях я ... Share your videos with friends, family, and the world. □□□□- Real Money Scratchcards Online - Play With Bitcoin □ □□□□- Real Money Scratchcards Online - Play With Bitcoin □ · v7j6k7-wud5s Purchase quantity:5699 · igfxru-4j13z Purchase quantity:7321 ... Domains v7j - Whois lookup Whois info of domain · Search whois domains with v7j · Alternative domains. Powertec Assembly Builds These videos show the assembly process for all of the Powertec Levergym, Strength, Racks, Cables, and Accessories. Thank you for purchasing your new Powertec equipment. To maximize the use of this equipment, please take a moment to study, understand and familiarize with the assembly instructions and follow the sequence of steps ... WORK BENCH - PowerTec Do not attempt to assemble or operate your work bench until you have read the safety instructions in this section.

- Only use your work bench on a hard, dry and. POWERTEC WB-MS14 MANUAL Pdf Download Place the bench press base over the bolts that come out of the lat pulldown base. Page 21 Bolt #72 Bolt #72 Using 2 x #72 bolts, with washers each side. Please ... PowerTec WB-MS16 Manual View and Download PowerTec WB-MS16 manual online. Workbench Multi System. WB-MS16 tool storage pdf manual download. Powertec Power Rack WB-PR16 Assembly guide Powertec Power Rack WB-PR16. Assembly guide. Before starting the assembly ... When assembling the machine do not tighten the bolts and nuts until after you. User manual Powertec WB-LS16 (English - 21 pages) Manual. View the manual for the Powertec WB-LS16 here, for free. This manual comes under the category fitness equipment and has been rated by 1 people with ... powertec® - workbench Assembly instructions, be careful to follow the sequence as provided in this Manual. Important Note: Do Not fully tighten bolts until assembly has been ...