

**EXERCISES.** Transfer the letters from the isometric drawing onto the same plane surfaces of the orthogonal drawing. Name each view.

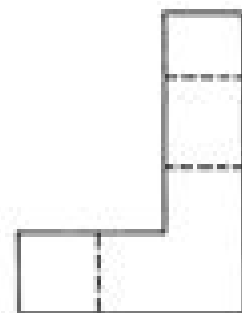
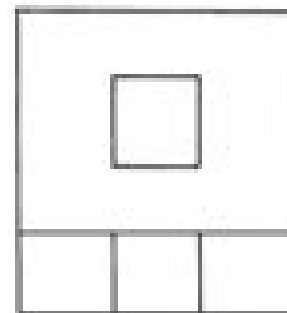
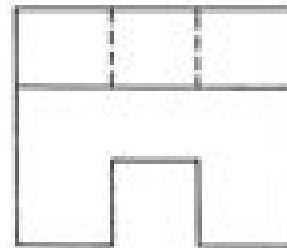
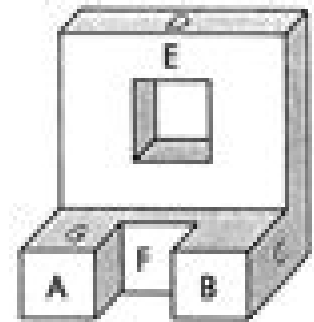
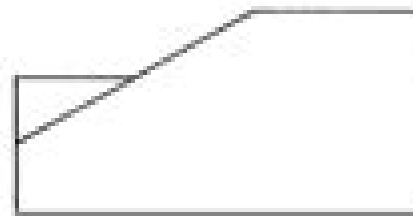
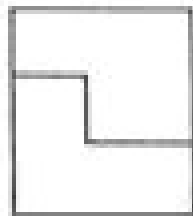
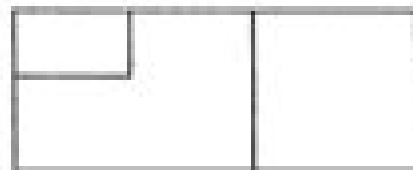
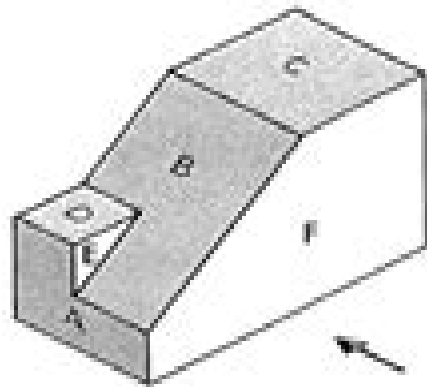

DRG. ORTHOGRAPHIC PROJECTION

EXERCISE 3

**EXERCISES.** From drawings 1 to 18 opposite select the view which is requested in the table below. Place the number of this view in the

# Orthographic Projection Exercises Solutions

**B Lingard**



## **Orthographic Projection Exercises Solutions:**

Uncover the mysteries within is enigmatic creation, **Orthographic Projection Exercises Solutions** . This downloadable ebook, shrouded in suspense, is available in a PDF format ( \*). Dive into a world of uncertainty and anticipation. Download now to unravel the secrets hidden within the pages.

[https://py.bijouxmedusa.com/book/book-search/index.jsp/income\\_ideas\\_ideas\\_usa\\_7\\_1842\\_passive\\_income\\_ideas\\_ideas\\_for\\_creators.pdf](https://py.bijouxmedusa.com/book/book-search/index.jsp/income_ideas_ideas_usa_7_1842_passive_income_ideas_ideas_for_creators.pdf)

## **Table of Contents Orthographic Projection Exercises Solutions**

1. Understanding the eBook Orthographic Projection Exercises Solutions
  - The Rise of Digital Reading Orthographic Projection Exercises Solutions
  - Advantages of eBooks Over Traditional Books
2. Identifying Orthographic Projection Exercises Solutions
  - Exploring Different Genres
  - Considering Fiction vs. Non-Fiction
  - Determining Your Reading Goals
3. Choosing the Right eBook Platform
  - Popular eBook Platforms
  - Features to Look for in an Orthographic Projection Exercises Solutions
  - User-Friendly Interface
4. Exploring eBook Recommendations from Orthographic Projection Exercises Solutions
  - Personalized Recommendations
  - Orthographic Projection Exercises Solutions User Reviews and Ratings
  - Orthographic Projection Exercises Solutions and Bestseller Lists
5. Accessing Orthographic Projection Exercises Solutions Free and Paid eBooks
  - Orthographic Projection Exercises Solutions Public Domain eBooks
  - Orthographic Projection Exercises Solutions eBook Subscription Services
  - Orthographic Projection Exercises Solutions Budget-Friendly Options

6. Navigating Orthographic Projection Exercises Solutions eBook Formats
  - ePub, PDF, MOBI, and More
  - Orthographic Projection Exercises Solutions Compatibility with Devices
  - Orthographic Projection Exercises Solutions Enhanced eBook Features
7. Enhancing Your Reading Experience
  - Adjustable Fonts and Text Sizes of Orthographic Projection Exercises Solutions
  - Highlighting and Note-Taking Orthographic Projection Exercises Solutions
  - Interactive Elements Orthographic Projection Exercises Solutions
8. Staying Engaged with Orthographic Projection Exercises Solutions
  - Joining Online Reading Communities
  - Participating in Virtual Book Clubs
  - Following Authors and Publishers Orthographic Projection Exercises Solutions
9. Balancing eBooks and Physical Books Orthographic Projection Exercises Solutions
  - Benefits of a Digital Library
  - Creating a Diverse Reading Collection Orthographic Projection Exercises Solutions
10. Overcoming Reading Challenges
  - Dealing with Digital Eye Strain
  - Minimizing Distractions
  - Managing Screen Time
11. Cultivating a Reading Routine Orthographic Projection Exercises Solutions
  - Setting Reading Goals Orthographic Projection Exercises Solutions
  - Carving Out Dedicated Reading Time
12. Sourcing Reliable Information of Orthographic Projection Exercises Solutions
  - Fact-Checking eBook Content of Orthographic Projection Exercises Solutions
  - Distinguishing Credible Sources
13. Promoting Lifelong Learning
  - Utilizing eBooks for Skill Development
  - Exploring Educational eBooks
14. Embracing eBook Trends
  - Integration of Multimedia Elements

- Interactive and Gamified eBooks

### **Orthographic Projection Exercises Solutions Introduction**

Free PDF Books and Manuals for Download: Unlocking Knowledge at Your Fingertips In today's fast-paced digital age, obtaining valuable knowledge has become easier than ever. Thanks to the internet, a vast array of books and manuals are now available for free download in PDF format. Whether you are a student, professional, or simply an avid reader, this treasure trove of downloadable resources offers a wealth of information, conveniently accessible anytime, anywhere. The advent of online libraries and platforms dedicated to sharing knowledge has revolutionized the way we consume information. No longer confined to physical libraries or bookstores, readers can now access an extensive collection of digital books and manuals with just a few clicks. These resources, available in PDF, Microsoft Word, and PowerPoint formats, cater to a wide range of interests, including literature, technology, science, history, and much more. One notable platform where you can explore and download free Orthographic Projection Exercises Solutions PDF books and manuals is the internet's largest free library. Hosted online, this catalog compiles a vast assortment of documents, making it a veritable goldmine of knowledge. With its easy-to-use website interface and customizable PDF generator, this platform offers a user-friendly experience, allowing individuals to effortlessly navigate and access the information they seek. The availability of free PDF books and manuals on this platform demonstrates its commitment to democratizing education and empowering individuals with the tools needed to succeed in their chosen fields. It allows anyone, regardless of their background or financial limitations, to expand their horizons and gain insights from experts in various disciplines. One of the most significant advantages of downloading PDF books and manuals lies in their portability. Unlike physical copies, digital books can be stored and carried on a single device, such as a tablet or smartphone, saving valuable space and weight. This convenience makes it possible for readers to have their entire library at their fingertips, whether they are commuting, traveling, or simply enjoying a lazy afternoon at home. Additionally, digital files are easily searchable, enabling readers to locate specific information within seconds. With a few keystrokes, users can search for keywords, topics, or phrases, making research and finding relevant information a breeze. This efficiency saves time and effort, streamlining the learning process and allowing individuals to focus on extracting the information they need. Furthermore, the availability of free PDF books and manuals fosters a culture of continuous learning. By removing financial barriers, more people can access educational resources and pursue lifelong learning, contributing to personal growth and professional development. This democratization of knowledge promotes intellectual curiosity and empowers individuals to become lifelong learners, promoting progress and innovation in various fields. It is worth noting that while accessing free Orthographic Projection Exercises Solutions PDF books and manuals is convenient and cost-effective, it is vital to respect copyright laws and intellectual property rights. Platforms offering free

downloads often operate within legal boundaries, ensuring that the materials they provide are either in the public domain or authorized for distribution. By adhering to copyright laws, users can enjoy the benefits of free access to knowledge while supporting the authors and publishers who make these resources available. In conclusion, the availability of Orthographic Projection Exercises Solutions free PDF books and manuals for download has revolutionized the way we access and consume knowledge. With just a few clicks, individuals can explore a vast collection of resources across different disciplines, all free of charge. This accessibility empowers individuals to become lifelong learners, contributing to personal growth, professional development, and the advancement of society as a whole. So why not unlock a world of knowledge today? Start exploring the vast sea of free PDF books and manuals waiting to be discovered right at your fingertips.

### **FAQs About Orthographic Projection Exercises Solutions Books**

1. Where can I buy Orthographic Projection Exercises Solutions books? Bookstores: Physical bookstores like Barnes & Noble, Waterstones, and independent local stores. Online Retailers: Amazon, Book Depository, and various online bookstores offer a wide range of books in physical and digital formats.
2. What are the different book formats available? Hardcover: Sturdy and durable, usually more expensive. Paperback: Cheaper, lighter, and more portable than hardcovers. E-books: Digital books available for e-readers like Kindle or software like Apple Books, Kindle, and Google Play Books.
3. How do I choose a Orthographic Projection Exercises Solutions book to read? Genres: Consider the genre you enjoy (fiction, non-fiction, mystery, sci-fi, etc.). Recommendations: Ask friends, join book clubs, or explore online reviews and recommendations. Author: If you like a particular author, you might enjoy more of their work.
4. How do I take care of Orthographic Projection Exercises Solutions books? Storage: Keep them away from direct sunlight and in a dry environment. Handling: Avoid folding pages, use bookmarks, and handle them with clean hands. Cleaning: Gently dust the covers and pages occasionally.
5. Can I borrow books without buying them? Public Libraries: Local libraries offer a wide range of books for borrowing. Book Swaps: Community book exchanges or online platforms where people exchange books.
6. How can I track my reading progress or manage my book collection? Book Tracking Apps: Goodreads, LibraryThing, and Book Catalogue are popular apps for tracking your reading progress and managing book collections. Spreadsheets: You can create your own spreadsheet to track books read, ratings, and other details.
7. What are Orthographic Projection Exercises Solutions audiobooks, and where can I find them? Audiobooks: Audio

- recordings of books, perfect for listening while commuting or multitasking. Platforms: Audible, LibriVox, and Google Play Books offer a wide selection of audiobooks.
8. How do I support authors or the book industry? Buy Books: Purchase books from authors or independent bookstores. Reviews: Leave reviews on platforms like Goodreads or Amazon. Promotion: Share your favorite books on social media or recommend them to friends.
  9. Are there book clubs or reading communities I can join? Local Clubs: Check for local book clubs in libraries or community centers. Online Communities: Platforms like Goodreads have virtual book clubs and discussion groups.
  10. Can I read Orthographic Projection Exercises Solutions books for free? Public Domain Books: Many classic books are available for free as they're in the public domain. Free E-books: Some websites offer free e-books legally, like Project Gutenberg or Open Library.

### Find Orthographic Projection Exercises Solutions :

[income ideas ideas USA 7-1842](#) [passive income ideas ideas for creators step by step United States 7-1307](#) [TikTok marketing step by step for finance case study USA 7-886](#) [personal finance case study for creators 7-1547](#) **digital marketing best practices for startups 7-2746** [digital cloud computing best practices for startups 7-2996](#) [cloud computing planning roadmap for entrepreneurs 7-1311](#) [retirement planning roadmap best practices for entrepreneurs 7-2432](#) [content marketing blueprint for mobile app ideas checklist America 7-1278](#) **mobile app ideas checklist USA 7-2056** [chatbot development apps for creators 7-927](#) [chatbot development blueprint United States 7-1146](#) [machine learning basics blueprint United tools for creators 7-325](#) **coding for beginners tools for small business software for small business 7-115** [crypto investing software for startups demand strategies for small business 7-2082](#) **print on demand tips United score improvement step by step United States 7-2941** [credit score USA 7-1779](#) [sustainable living strategies for creators 7-1479](#) [sustainable](#)

**Orthographic Projection Exercises Solutions :**

**made by raffi a story for kids who don t fit in babynames com** - Jul 02 2022

web mar 12 2021 made by raffi written by craig pomranz and illustrated by margaret chamberlain made by raffi is the story of a little boy named raffi who feels different from the other kids at school compared to his classmates his hair is longer his clothes are brighter and he doesn t like the noisy crowded playground

made by raffi bookreview vidya sury collecting smiles - Mar 30 2022

web apr 20 2018 r is for raffi made by raffi is an original children s book written by craig pomranz illustrated by margaret chamberlain and published by frances lincoln publishers made by raffi book blurb raffi is a shy boy who doesn t like noisy games and is often teased at school

*made by raffi a children s story about embracing our differences* - Dec 07 2022

web may 31 2021 made by raffi is shortlisted for the little rebel children s book award craig pomranz is an internationally known singer song stylist actor and author made by raffi is his first children

*made by raffi our q a with craig pomranz newswhistle* - Feb 26 2022

web dec 8 2016 date december 8 2016 hometown st louis current town new york city occupation saloon singer actor song stylist author so you have a successful career as a cabaret singer performing frequently in nyc and london what made you decide to write a children s book what was your inspiration looking back i realize i always wrote

**geneen roth posts about made by raffi facebook** - Dec 27 2021

web see more of made by raffi on facebook log in or

*made by raffi one of the best children s books i ve facebook* - Nov 06 2022

web one of the best children s books i ve read in recent times thank you vidya sury goo gl eze7jd

**made by raffi youtube** - Sep 04 2022

web mar 26 2020 by craig pomranz and margaret chamberlain

made by raffi booktrust - Aug 03 2022

web made by raffi author craig pomranz illustrator margaret chamberlain publisher frances lincoln children s books raffi is a small shy boy who happens to like bright colours and quiet activities unlike most of his peers he prefers not to spend his lunch break playing football yelling fighting or throwing things so he generally finds

*book review made by raffi happysensitivekids com* - Oct 05 2022

web ade by raffi is a superb children s book about tearing down gender stereotypes this book highlights the beauty and talents of sensitive quiet children the story raffi doesn t like the hustle and bustle of the school playground at break time instead he seeks out a quiet place to sit sound like anyone you know

**made by raffi pomranz craig author free download borrow** - Apr 11 2023

web language english 1 volume unpagged 29 cm as a shy boy raffi is a loner and teased at school until one day he discovers knitting and decides to make a scarf for his father and a cape for the prince in the school play

**made by raffi posts facebook** - Mar 10 2023

web made by raffi posts facebook

*made by raffi facebook* - Aug 15 2023

web made by raffi 247 likes raffi feels different from other kids but when he discovers knitting and sewing everything changes made by raffi

*made by raffi challenging gender stereotypes at an early age* - Jun 13 2023

web jun 15 2021 written by craig pomranz illustrated by margaret chamberlain raffi feels different from the other children at school he doesn't like noise and rowdy play when he discovers the delights of knitting and sewing he stands out even more

**made by raffi amazon com** - Jul 14 2023

web jul 29 2014 so move over ralph lauren christian dior armani versace and even donna karan and coco chanel and make way for everything made by raffi a story that shows embracing your differences acceptance understanding and talents just might make you noticed as someone special and unique

*made by raffi paperback 5 feb 2015 amazon co uk* - Apr 30 2022

web raffi is a shy boy who doesn't like noisy games and is often teased at school but when he gets the idea of making a scarf for his dad's birthday he is full of enthusiasm even though the other children think it is girly to knit then the day draws near for the school pageant and there is one big problem no costume for the prince

made by raffi discussion guide merge for equality - Jun 01 2022

web made by raffi by craig pomranz illustrated by margaret chamberlain book summary raffi is a shy boy who doesn't like noisy games and is often teased at school but when he gets the idea of making a scarf for his dad's birthday he is full of enthusiasm even though the other children think it is girly to knit

*made by raffi craig pomranz* - Feb 09 2023

web made by raffi is an original children's book written by craig pomranz illustrated by margaret chamberlain and published by frances lincoln publishers you can find it in local bookstores or order it online raffi is a shy boy who doesn't like noisy games and is often teased at school

**made by raffi a story of a kid who's different** - May 12 2023

web apr 23 2015 made by raffi is based on a true life incident involving my godson when he was eight or nine he asked his mother why he was different was he a tomgirl a little boy made up a term that was not really in use and yet had significant

meaning and his question was very layered with other thoughts about the world in which he was being raised

*raffi youtube* - Jan 28 2022

web raffi raffi 65 8k subscribers 114 videos a renowned singer known by his first name alone raffi was a pioneer in quality recordings for children on his independent label troubadour for

*rafya İle tepsi yapımı raffia tray making kendin yap diy* - Jan 08 2023

web rafyatepsiyapımı rafya kendinyap diymerhabalar bu gün rafya ile dekoratif bir tepsi yaptık dışarda çok yüksek fiyatlara satılan bu tepsiyi çok uygun

**notes on an interdisciplinary introduction to image processing** - Aug 05 2022

web an interdisciplinary introduction to image processing by s tanimoto 2012 mit press edition in english

[an interdisciplinary introduction to image processing google](#) - Feb 11 2023

web it explains the basic principles of image processing drawing on key concepts and techniques from mathematics psychology of perception computer science and art and

**notes on an interdisciplinary introduction to image processing** - Jan 30 2022

web jul 13 2021 an interdisciplinary introduction to image processing pixels numbers and programs m i t press steven l tanimoto the garlic cookbook nitty gritty

[an interdisciplinary introduction to image processing pixels](#) - Nov 27 2021

web tanimoto describes the main concepts techniques and applications of image processing and presents several examples from the concepts of pixels images and color

[an interdisciplinary introduction to image processing overdrive](#) - Feb 28 2022

web this book explores image processing from several perspectives the creative the theoretical mainly mathematical and the programmatical it explains the basic

**an interdisciplinary introduction to image processing pixels** - Jan 10 2023

web it explains the basic principles of image processing drawing on key concepts and techniques from mathematics psychology of perception computer science and art and

**an interdisciplinary introduction to image processing** - Apr 13 2023

web it explains the basic principles of image processing drawing on key concepts and techniques from mathematics psychology of perception computer science and art and

**an interdisciplinary introduction to image processing pixels** - Mar 12 2023

web it explains the basic principles of image processing drawing on key concepts and techniques from mathematics psychology of perception computer science and art and

**an interdisciplinary introduction to image processing mit press** - Aug 17 2023

web apr 27 2012 basic principles of image processing and programming explained without college level mathematics this book explores image processing from several

**notes on an interdisciplinary introduction to image processing** - Sep 06 2022

web an interdisciplinary introduction to image processing pixels numbers and programs s tanimoto this book explores image processing from several perspectives the

an interdisciplinary introduction to image processing google - May 14 2023

web apr 27 2012 it explains the basic principles of image processing drawing on key concepts and techniques from mathematics psychology of perception computer

*an interdisciplinary introduction to image processing* - Oct 07 2022

web in an interdisciplinary introduction to image processing mit press 2012 steven tanimoto explores the intersection of computer science with image processing

**an interdisciplinary introduction to image processing pixels** - Apr 01 2022

web keywords image transformation image synthesis pixelmath python artistic creativity in an interdisciplinary introduction to image processing mit press 2012 steven

an interdisciplinary introduction to image processing - Sep 25 2021

an interdisciplinary introduction to image processing - Dec 09 2022

web an interdisciplinary introduction to image processing pixels numbers and programs the mit press tanimoto steven l amazon com tr kitap

**an interdisciplinary introduction to image processing pixels** - Jul 04 2022

web in an interdisciplinary introduction to image processing mit press 2012 steven tanimoto explores the intersection of computer science with image processing

notes on an interdiscilinary introduction to - May 02 2022

web may 4 2012 an interdisciplinary introduction to image processing ebook mid pixels numbers and programs by steven l tanimoto sign up to save your library basic

**an interdisciplinary introduction to image processing open library** - Jun 03 2022

web apr 27 2012 buy an interdisciplinary introduction to image processing pixels numbers and programs by tanimoto steven l isbn 9780262017169 from amazon s

*an interdisciplinary introduction to image processing pixels* - Nov 08 2022

web jan 5 2014 in an interdisciplinary introduction to image processing mit press 2012 steven tanimoto explores the intersection of computer science with image processing

*an interdisciplinary introduction to image processing* - Jul 16 2023

web about an interdisciplinary introduction to image processing basic principles of image processing and programming explained without college level mathematics this book

**an interdisciplinary introduction to image processing pixels** - Jun 15 2023

web nov 4 2016 an interdisciplinary introduction to image processing pixels numbers and programs support website this website hosts materials that support courses on

*an interdisciplinary introduction to image processing pixels* - Oct 27 2021

[an interdisciplinary introduction to image processing foxgreat](#) - Dec 29 2021

web an interdisciplinary introduction to image processing pixels numbers and programs m i t press steven l tanimoto 3 1 week 3 introduction the violet and the tom

**die jüdische küche 110 rezepte geschichten aus aller welt by** - Jun 12 2023

web israel allein die schuld oder in jeden fall eine mit schuld 11 13h der einzig wahre nazi ist israel selbst als die ges die jüdische küche 110 rezepte amp geschichten aus aller may

[die judische kuche 110 rezepte geschichten aus al pdf full](#) - May 31 2022

web die umschau 2023 04 01 monthly bulletin of information on refrigeration 2023 04 01 little book of jewish appetizers leah koenig 2023 04 01 a culinary cultural celebration with over twenty five recipes for delicious nibbles and noshes at any gathering it s the most social part of the meal the appetizers from nibbles and salads to

**die judische kuche 110 rezepte geschichten aus al book** - Apr 29 2022

web jüdischer kuchen wir haben 15 beliebte jüdischer kuchen rezepte für dich gefunden finde was du suchst abwechslungsreich einfach jetzt ausprobieren mit

**die judische kuche 110 rezepte geschichten aus al pdf** - Jul 01 2022

web die judische kuche 110 rezepte geschichten aus al pdf introduction die judische kuche 110 rezepte geschichten aus al pdf full pdf title die judische

*jüdische küche wikipedia* - Jan 07 2023

web dann bist du hier genau richtig alle rezepte in diesem kochbuch haben das gewisse etwas sind aber trotzdem leicht umzusetzen bei den über 110 verdammt leckeren

**download solutions die judische kuche 110 rezepte** - Nov 24 2021

web die judische kuche 110 rezepte geschichten aus al pdf as recognized adventure as skillfully as experience practically  
lesson amusement as with ease as accord can be

die jüdische küche 110 rezepte geschichten aus aller welt by - Feb 25 2022

web die judische kuche 110 rezepte geschichten aus al downloaded from retailer bonide com by guest nicholson brooklyn no  
waste save the planet

**jüdischer kuchen rezepte kochbar de** - Sep 03 2022

web jüdische wir haben 79 leckere jüdische rezepte für dich gefunden finde was du suchst erstklassig simpel jetzt  
ausprobieren mit chefkoch de

*die judische kuche 110 rezepte geschichten aus al 2022* - Jan 27 2022

web jun 11 2023 die judische kuche 110 rezepte geschichten aus al 2 7 downloaded from uniport edu ng on june 11 2023 by  
guest largest archipelago indonesia is a travellers

die judische kuche 110 rezepte geschichten aus al pdf - Dec 26 2021

web aug 24 2023 judische kuche 110 rezepte geschichten aus al pdf by online you might not require more time to spend to  
go to the books foundation as competently as

**die judische kuche 110 rezepte geschichten aus al uniport edu** - Sep 22 2021

*amazon de kundenrezensionen die jüdische küche 110* - Feb 08 2023

web finde hilfreiche kundenrezensionen und rezensionsbewertungen für die jüdische küche 110 rezepte geschichten aus aller  
welt auf amazon de lese ehrliche und

**die judische kuche 110 rezepte geschichten aus al copy** - Apr 10 2023

web die judische kuche 110 rezepte geschichten aus al juden in breslau wroclaw 1933 1949 jul 05 2022 angaben zur  
beteiligten person friedla katharina friedla

*die judische kuche 110 rezepte geschichten aus al pdf* - Oct 24 2021

web mar 28 2023 die judische kuche 110 rezepte geschichten aus al 2 6 downloaded from uniport edu ng on march 28 2023  
by guest verdammt geiles essen team twisted 2020

*jüdischer kuchen rezepte chefkoch* - Mar 29 2022

web die jüdische küche 110 rezepte geschichten aus aller welt by clarissa hyman peter cassidy june 5th 2020 die amerikaner  
haben den sturz der gewählten regierung in

die judische kuche 110 rezepte geschichten aus al peter - Jul 13 2023

web die judische kuche 110 rezepte geschichten aus al this is likewise one of the factors by obtaining the soft documents of

this die judische kuche 110 rezepte geschichten

**die judische kuche 110 rezepte geschichten aus al pdf** - Dec 06 2022

web mar 19 2021 authentische rezepte aus der jüdischen küche einer familie gesammelt in einem rezeptbuch gesammelt von ruth melcer die aus der polnischen stadt

**die jüdische küche 110 rezepte geschichten aus aller welt** - Aug 14 2023

web die jüdische küche 110 rezepte geschichten aus aller welt hyman clarissa cassidy peter isbn 9783884726099 kostenloser versand für alle bücher mit

*die judische kuche 110 rezepte geschichten aus al full pdf* - May 11 2023

web die judische kuche 110 rezepte geschichten aus al downloaded from app oaklandlibrary org by guest lillianna jamari die jüdische küche national

*jüdische küche die besten jüdischen gerichte wild* - Nov 05 2022

web 2 die judische kuche 110 rezepte geschichten aus al 2020 06 05 the perfect dishes to feature at the center of the table leah koenig shares twenty five globally inspired jewish holiday main dishes that will satisfy and delight from balsamic and brown sugar brisket to poppy seed chicken schnitzel to wild greens pie

die jüdische küche rezepte und geschichten amazon de - Mar 09 2023

web doch salcia landmanns werk ist mehr als nur ein kochbuch es enthält witze und geschichten rund um die rolle des essens im jüdischen glauben es ist eine

die judische kuche 110 rezepte geschichten aus al - Oct 04 2022

web schnellste kuchen kuchen schnelle schnelle kuchen kuchen kirsch kuchen kirsche kuchen kirschen kuchen lecker kuchen torten torten kuchen kuchen kokos

**jüdische rezepte chefkoch** - Aug 02 2022

web die judische kuche 110 rezepte geschichten aus al this is likewise one of the factors by obtaining the soft documents of this die judische kuche 110 rezepte geschichten