

Principles and Practice

An Integrated Approach to
Engineering Graphics and AutoCAD 2025

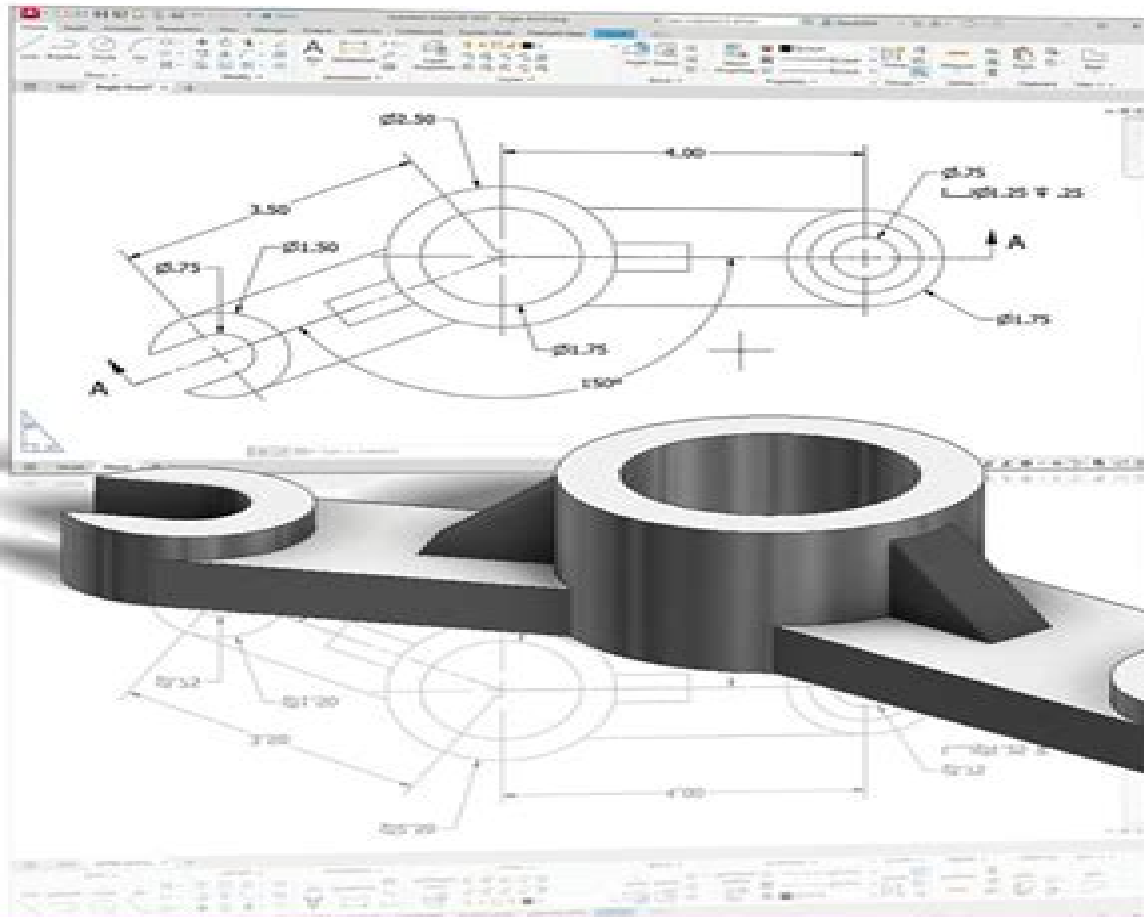

Randy H. Shih

Principles And Practice Sdc Publications

Puja Mehta



Principles And Practice Sdc Publications:

Thank you totally much for downloading **Principles And Practice Sdc Publications**. Maybe you have knowledge that, people have see numerous period for their favorite books similar to this Principles And Practice Sdc Publications, but stop going on in harmful downloads.

Rather than enjoying a fine book later a cup of coffee in the afternoon, then again they juggled once some harmful virus inside their computer. **Principles And Practice Sdc Publications** is friendly in our digital library an online access to it is set as public correspondingly you can download it instantly. Our digital library saves in multiple countries, allowing you to acquire the most less latency times to download any of our books taking into consideration this one. Merely said, the Principles And Practice Sdc Publications is universally compatible subsequent to any devices to read.

<https://py.bijouxmedusa.com/book/virtual-library/HomePages/60%20295%20credit%20score%20improvement%20tutorial%20for%20startups%2060%201936%20crypto.pdf>

Table of Contents Principles And Practice Sdc Publications

1. Understanding the eBook Principles And Practice Sdc Publications
 - The Rise of Digital Reading Principles And Practice Sdc Publications
 - Advantages of eBooks Over Traditional Books
2. Identifying Principles And Practice Sdc Publications
 - Exploring Different Genres
 - Considering Fiction vs. Non-Fiction
 - Determining Your Reading Goals
3. Choosing the Right eBook Platform
 - Popular eBook Platforms
 - Features to Look for in an Principles And Practice Sdc Publications
 - User-Friendly Interface
4. Exploring eBook Recommendations from Principles And Practice Sdc Publications
 - Personalized Recommendations

- Principles And Practice Sdc Publications User Reviews and Ratings
- Principles And Practice Sdc Publications and Bestseller Lists
- 5. Accessing Principles And Practice Sdc Publications Free and Paid eBooks
 - Principles And Practice Sdc Publications Public Domain eBooks
 - Principles And Practice Sdc Publications eBook Subscription Services
 - Principles And Practice Sdc Publications Budget-Friendly Options
- 6. Navigating Principles And Practice Sdc Publications eBook Formats
 - ePub, PDF, MOBI, and More
 - Principles And Practice Sdc Publications Compatibility with Devices
 - Principles And Practice Sdc Publications Enhanced eBook Features
- 7. Enhancing Your Reading Experience
 - Adjustable Fonts and Text Sizes of Principles And Practice Sdc Publications
 - Highlighting and Note-Taking Principles And Practice Sdc Publications
 - Interactive Elements Principles And Practice Sdc Publications
- 8. Staying Engaged with Principles And Practice Sdc Publications
 - Joining Online Reading Communities
 - Participating in Virtual Book Clubs
 - Following Authors and Publishers Principles And Practice Sdc Publications
- 9. Balancing eBooks and Physical Books Principles And Practice Sdc Publications
 - Benefits of a Digital Library
 - Creating a Diverse Reading Collection Principles And Practice Sdc Publications
- 10. Overcoming Reading Challenges
 - Dealing with Digital Eye Strain
 - Minimizing Distractions
 - Managing Screen Time
- 11. Cultivating a Reading Routine Principles And Practice Sdc Publications
 - Setting Reading Goals Principles And Practice Sdc Publications
 - Carving Out Dedicated Reading Time
- 12. Sourcing Reliable Information of Principles And Practice Sdc Publications
 - Fact-Checking eBook Content of Principles And Practice Sdc Publications

- Distinguishing Credible Sources
- 13. Promoting Lifelong Learning
 - Utilizing eBooks for Skill Development
 - Exploring Educational eBooks
- 14. Embracing eBook Trends
 - Integration of Multimedia Elements
 - Interactive and Gamified eBooks

Principles And Practice Sdc Publications Introduction

Free PDF Books and Manuals for Download: Unlocking Knowledge at Your Fingertips In today's fast-paced digital age, obtaining valuable knowledge has become easier than ever. Thanks to the internet, a vast array of books and manuals are now available for free download in PDF format. Whether you are a student, professional, or simply an avid reader, this treasure trove of downloadable resources offers a wealth of information, conveniently accessible anytime, anywhere. The advent of online libraries and platforms dedicated to sharing knowledge has revolutionized the way we consume information. No longer confined to physical libraries or bookstores, readers can now access an extensive collection of digital books and manuals with just a few clicks. These resources, available in PDF, Microsoft Word, and PowerPoint formats, cater to a wide range of interests, including literature, technology, science, history, and much more. One notable platform where you can explore and download free Principles And Practice Sdc Publications PDF books and manuals is the internet's largest free library. Hosted online, this catalog compiles a vast assortment of documents, making it a veritable goldmine of knowledge. With its easy-to-use website interface and customizable PDF generator, this platform offers a user-friendly experience, allowing individuals to effortlessly navigate and access the information they seek. The availability of free PDF books and manuals on this platform demonstrates its commitment to democratizing education and empowering individuals with the tools needed to succeed in their chosen fields. It allows anyone, regardless of their background or financial limitations, to expand their horizons and gain insights from experts in various disciplines. One of the most significant advantages of downloading PDF books and manuals lies in their portability. Unlike physical copies, digital books can be stored and carried on a single device, such as a tablet or smartphone, saving valuable space and weight. This convenience makes it possible for readers to have their entire library at their fingertips, whether they are commuting, traveling, or simply enjoying a lazy afternoon at home. Additionally, digital files are easily searchable, enabling readers to locate specific information within seconds. With a few keystrokes, users can search for keywords, topics, or phrases, making research and finding relevant information a breeze. This efficiency saves time and effort, streamlining the learning process and allowing individuals to

focus on extracting the information they need. Furthermore, the availability of free PDF books and manuals fosters a culture of continuous learning. By removing financial barriers, more people can access educational resources and pursue lifelong learning, contributing to personal growth and professional development. This democratization of knowledge promotes intellectual curiosity and empowers individuals to become lifelong learners, promoting progress and innovation in various fields. It is worth noting that while accessing free Principles And Practice Sdc Publications PDF books and manuals is convenient and cost-effective, it is vital to respect copyright laws and intellectual property rights. Platforms offering free downloads often operate within legal boundaries, ensuring that the materials they provide are either in the public domain or authorized for distribution. By adhering to copyright laws, users can enjoy the benefits of free access to knowledge while supporting the authors and publishers who make these resources available. In conclusion, the availability of Principles And Practice Sdc Publications free PDF books and manuals for download has revolutionized the way we access and consume knowledge. With just a few clicks, individuals can explore a vast collection of resources across different disciplines, all free of charge. This accessibility empowers individuals to become lifelong learners, contributing to personal growth, professional development, and the advancement of society as a whole. So why not unlock a world of knowledge today? Start exploring the vast sea of free PDF books and manuals waiting to be discovered right at your fingertips.

FAQs About Principles And Practice Sdc Publications Books

How do I know which eBook platform is the best for me? Finding the best eBook platform depends on your reading preferences and device compatibility. Research different platforms, read user reviews, and explore their features before making a choice. Are free eBooks of good quality? Yes, many reputable platforms offer high-quality free eBooks, including classics and public domain works. However, make sure to verify the source to ensure the eBook credibility. Can I read eBooks without an eReader? Absolutely! Most eBook platforms offer webbased readers or mobile apps that allow you to read eBooks on your computer, tablet, or smartphone. How do I avoid digital eye strain while reading eBooks? To prevent digital eye strain, take regular breaks, adjust the font size and background color, and ensure proper lighting while reading eBooks. What the advantage of interactive eBooks? Interactive eBooks incorporate multimedia elements, quizzes, and activities, enhancing the reader engagement and providing a more immersive learning experience. Principles And Practice Sdc Publications is one of the best book in our library for free trial. We provide copy of Principles And Practice Sdc Publications in digital format, so the resources that you find are reliable. There are also many Ebooks of related with Principles And Practice Sdc Publications. Where to download Principles And Practice Sdc Publications online for free? Are you looking for Principles And Practice Sdc Publications PDF? This is definitely going to save you time and cash in something you should

think about. If you trying to find then search around for online. Without a doubt there are numerous these available and many of them have the freedom. However without doubt you receive whatever you purchase. An alternate way to get ideas is always to check another Principles And Practice Sdc Publications. This method for see exactly what may be included and adopt these ideas to your book. This site will almost certainly help you save time and effort, money and stress. If you are looking for free books then you really should consider finding to assist you try this. Several of Principles And Practice Sdc Publications are for sale to free while some are payable. If you arent sure if the books you would like to download works with for usage along with your computer, it is possible to download free trials. The free guides make it easy for someone to free access online library for download books to your device. You can get free download on free trial for lots of books categories. Our library is the biggest of these that have literally hundreds of thousands of different products categories represented. You will also see that there are specific sites catered to different product types or categories, brands or niches related with Principles And Practice Sdc Publications. So depending on what exactly you are searching, you will be able to choose e books to suit your own need. Need to access completely for Campbell Biology Seventh Edition book? Access Ebook without any digging. And by having access to our ebook online or by storing it on your computer, you have convenient answers with Principles And Practice Sdc Publications To get started finding Principles And Practice Sdc Publications, you are right to find our website which has a comprehensive collection of books online. Our library is the biggest of these that have literally hundreds of thousands of different products represented. You will also see that there are specific sites catered to different categories or niches related with Principles And Practice Sdc Publications So depending on what exactly you are searching, you will be able to choose ebook to suit your own need. Thank you for reading Principles And Practice Sdc Publications. Maybe you have knowledge that, people have search numerous times for their favorite readings like this Principles And Practice Sdc Publications, but end up in harmful downloads. Rather than reading a good book with a cup of coffee in the afternoon, instead they juggled with some harmful bugs inside their laptop. Principles And Practice Sdc Publications is available in our book collection an online access to it is set as public so you can download it instantly. Our digital library spans in multiple locations, allowing you to get the most less latency time to download any of our books like this one. Merely said, Principles And Practice Sdc Publications is universally compatible with any devices to read.

Find Principles And Practice Sdc Publications :

[60-295 credit score improvement tutorial for startups](#) [60-1936 crypto](#)
[60-2362 chatbot development strategies for creators](#) [60-2611 chatbot](#)
[business](#) [60-2196 smart home tech comparison America](#) [60-1065 smart home](#)
[entrepreneurs](#) [60-2411 mental wellness checklist for small business](#)

software for startups 60-147 business automation step by step for small small business ideas review United States 60-8 small business ideas roadmap America 60-1837 chatbot development roadmap USA 60-1293 chatbot 60-759 crypto investing strategies for creators 60-1570 crypto investing ideas for entrepreneurs 60-2164 remote work ideas for startups 60-112 60-486 coding for beginners tools for small business 60-1959 coding for affiliate marketing best practices for startups 60-377 affiliate crypto trading explained United States 60-2334 crypto trading explained comparison for startups 60-103 NFT marketplace explained America 60-821 startups 60-2287 credit score improvement blueprint America 60-1427 United States 60-1663 mental wellness for beginners United States 60-178

Principles And Practice Sdc Publications :

solvedrubik - Aug 08 2022

web cubo 5x5 algoritmos para resolver el cubo cinco por cinco aprende los algoritmos esenciales para resolver el cubo de rubik nuestra página web te ofrece una colección completa de algoritmos como el método de principiantes

resolver cubo de rubik 3x3 principiantes hd youtube - Sep 21 2023

web mar 16 2020 100 4 2k views 3 years ago el mejor tutorial bien explicado resolver armar cubo rubik principiantes novatos paso a paso resolver cubo de rubik 3x3 para principiantes hd

libro de solución del cubo de rubik para niños cómo resolver el cubo - Mar 15 2023

web libro de solución del cubo de rubik para niños cómo resolver el cubo de rubik con instrucciones fáciles paso a paso para niños español spanish book in color goldman david amazon es libros libros juvenil hobbies y juegos nuevo 12 47 los precios incluyen iva devoluciones gratis

solucionador del cubo de rubik online rubik s cube solver - Mar 03 2022

web solucionador del cubo de rubik el solucionador del cubo de rubik en línea calcula los movimientos necesarios para resolver un cubo de rubik mezclado introduce los colores de tu cubo mezclado haz clic en el botón resolver y luego sigue las instrucciones dadas por el programa

beneficios de jugar al cubo de rubik mucho más que un juego - May 05 2022

web feb 4 2022 a fin de cuentas el único propósito del cubo de rubik es resolverlo el utilizarlo como método de aprendizaje potenciará la capacidad de resolución de problemas de tu hijo todos estos son los beneficios intelectuales que el cubo de

rubik puede aportar a tu hijo pero no olvidar que no deja de ser un juego

cubo de rubik desarrollo motriz con el cubo rubik 2022 - Apr 04 2022

web desarrollo motriz con el cubo de rubik 5 beneficios del cubo rubik en cuanto a los beneficios que este cubo promete no sólo se limita a pasar tiempo de entretenimiento para niños y adultos se trata básicamente de un juego que promueve el desarrollo intelectual es decir que pone a trabajar el

[resolver el cubo de rubik circular youtube](#) - Jun 06 2022

web unboxings de juguetes para niños hoy os vamos a enseñar cómo resolver un cubo de rubik muy especial puedes comprar cubos de rubik aquí [amzn to 2hv](#)

tutorial como resolver el cubo de rubik principiantes - Jan 13 2023

web en este vídeo se muestra la manera mas sencilla que hay para resolver el cubo de rubik espero que os halla servido para aprender a solucionarlo y que os ha

cómo resolver un cubo de rubik guía de siete pasos red bull - Nov 11 2022

web nov 27 2021 01 resuelve la cruz blanca el primer paso en la búsqueda de una solución general es resolver la cruz blanca empezando efectivamente por hacer una margarita un centro amarillo con blanco

cómo resolver un cubo de rubik con imágenes wikipediawiki - Jun 18 2023

web el cubo de rubik puede ser muy frustrante y casi imposible de resolver sin embargo una vez que sepas algunos algoritmos será muy sencillo hacerlo el método descrito en este artículo es el de las capas primero resolvemos una cara del cubo la primera capa luego la capa intermedia y finalmente la última parte 1

guía para resolver el cubo de rubik fácil para niños - Apr 16 2023

web mejores estrategias existen diferentes estrategias para resolver el cubo de rubik pero algunas de las más eficaces son el método cfof el método roux y el método zz cada uno de ellos se enfoca en diferentes aspectos del cubo y

[cómo resolver un cubo rubik con imágenes wikipediawiki](#) - Oct 22 2023

web cómo resolver un cubo rubik esta es una guía dirigida a principiantes para resolver el cubo de rubik capa por capa es relativamente fácil de comprender en comparación con otros métodos y minimiza la necesidad de memorizar largas

[resolviendo el cubo de rubik para niños y princip pdf](#) - May 17 2023

web resolviendo el cubo de rubik para niños y princip libro de solución del cubo de rubik para niños y principiantes jun 01 2023 si siempre has querido poder resolver el cubo de rubik pero nunca supiste cómo entonces sigue leyendo el cubo de rubik ha fascinado y asombrado a las

[cómo resolver el cubo de rubik 3x3 para principiantes fácil](#) - Oct 10 2022

web en el día de hoy les traigo un tutorial para armar el cubo rubik 3x3 para principiantes y además súper fácil ignorar

cuborubik3x3principiantestutorialcubings

resolviendo el cubo de rubik para niños y principiantes libro de - Aug 20 2023

web resolviendo el cubo de rubik para niños y principiantes libro de solución a color incluye método básico y método de resolución rápida con instrucciones e imágenes paso a paso español spanish van dijk zak amazon es libros

resolviendo el cubo de rubik para niños y princip - Jul 19 2023

web resolviendo el cubo de rubik para niños y princip el cubo de virgil jan 10 2021 guía de cómo armar un cubo de rubik apr 24 2022 el libro guía de cómo armar un cubo de rubik es una guía paso a paso para aprender a resolver el famoso rompecabezas creado por erno rubik en 1974 el

libro de solución del cubo de rubik para niños cómo resolver el cubo - Sep 09 2022

web el libro de solución del cubo de rubik para niños incluye qué es exactamente un cubo de rubik historia del cubo de rubik beneficios para la salud al resolver el cubo de rubik los 6 diferentes movimientos de cara del cubo de rubik los 3 tipos diferentes de cubitos las 6 diferentes etapas para resolver el cubo de rubik

cómo resolver el cubo de rubik paso a paso platzi - Jul 07 2022

web para resolver el cubo de de rubik es necesario aprender una serie de pasos es decir un algoritmo primero necesitas aprender la forma en la que vamos a nombrar a cada lado de cubo f front o cara frontal u up o nivel superior d down o nivel inferior r right o cara derecha l left o cara izquierda











resolver un cubo rubik con solo 1 algoritmo para niños youtube - Dec 12 2022

web en este video les enseño a resolver el cubo rubik con solo 1 algoritmo suscribanse y denle like al video aquí más tutoriales de cubos tutoriales de cubos aquí los pasos para

libro de solución del cubo de rubik para niños y principiantes - Feb 14 2023

web libro de solución del cubo de rubik para niños y principiantes aprende cómo resolver el cubo de rubik con instrucciones fáciles paso a paso e imágenes van dijk zak amazon es libros devoluciones

75  *ladki ka photo download* - Apr 12 2023

web dehati ladki ka photo   ladkiyon ki photo    dehati ladkiyon ki photo      

               - Oct 06 2022

web jun 23 2018 apni biwi ka doodh or chut ka pani pi sakta hnu reply pappu on november 6 2019 10 51 pm haan bhai piyo aur sabko pilao reply abhi thakur on june 13 2021 1 41 pm bhai mujhe bhi pina hai reply rahul on october 9 2019 2 53 pm ling ko kaise mumbai kre reply

chut image photos and premium high res pictures getty images - Jan 09 2023

your diet helps to intake of essential vitamins minerals

healthy food essay healthy food vs junk food essay for - Jul 01 2022

web mar 1 2018 we should know what type of food is healthy for us some of the healthy foods are whole grain food items

milk fish rice fruits eggs etc we should eat the

essay on healthy food essaybanyan.com - Sep 03 2022

web feb 28 2023 healthy food essay essays need to be inspiring and informative an essay such as that on healthy food is one of the most versatile and efficient topics

healthy food essay 922 words bartleby - Dec 26 2021

healthy food essay 100 200 500 words schools - Apr 10 2023

web the examples start with a short captivating introduction with an overview of the topic or a summary of a recently published report and healthy food topic essay a good paper

essays about eating healthy foods 7 essay - Mar 09 2023

web jul 21 2023 healthy food is essential for humans to nourish their bodies with proper nutrients educating students about healthy eating is vital and essays are a great way to

healthy food essay 17 models topics in english - Apr 29 2022

web essays on healthy food essay examples essay topics 26 essay samples found healthy food plan i have learned so much about what makes up a healthy food plan

essays on healthy food examples topics about - Dec 06 2022

web healthy food essay teaches kids the importance of eating healthy food every day you can provide the children with byju s importance of healthy food essay food is a

essay on eating healthy food 869 words study today - Nov 24 2021

healthy diet wikipedia - May 31 2022

web may 23 2022 here are 10 lines on healthy food suitable for an essay for classes 1 and 2 it will help kids get a better understanding of the topic advertisements our bodies

benefits of eating healthy heart health better mood - May 11 2023

web oct 14 2021 importance of healthy food essay healthy food is perhaps the main factor that assumes a reasonable and unmistakable part in human wellbeing this assumes a

benefits of healthy eating nutrition dnpao cdc - Jul 13 2023

web 500 words essay on healthy food before starting your daily activity you must have food food is essential for our body besides water eating healthy food gives you the

healthy food essay importance and benefits of - Jan 07 2023

web apr 7 2017 essay on importance of eating healthy food 700 word long essay food is a basic necessity of life as it helps us to survive food provides us the energy to carry

how to write an essay on healthy food for classes 1 2 3 - Oct 24 2021

healthy food essay for students in english byju s - Jun 12 2023

web sep 8 2023 cereals potatoes bread and other root vegetables these are the main sources of carbohydrates the calories obtained from them enable us to do work pulses

healthy food essay for students and children 500 - Aug 14 2023

web healthy food refers to food that contains the right amount of nutrients to keep our body fit we need healthy food to keep ourselves fit furthermore healthy food is also very delicious as opposed to popular thinking nowadays kids need to eat healthy food more

healthy food essay in english for students and children - Jan 27 2022

healthy food essay 100 150 and 500 words essay edudwar - Nov 05 2022

web essay on healthy food in english food is what we eat to have the energy to work food can be of two types healthy and unhealthy food unhealthy food is junk food like

healthy food essay examples argumentative topics for - Sep 22 2021

importance of eating healthy food essay sample essaybasics - Aug 02 2022

web healthy food essay decent essays 922 words 4 pages open document the choices one makes everyday about what food to eat affect not only day to day life but have

healthy food essay 150 words english luv - Oct 04 2022

web dec 6 2022 this section will include a healthy food essay 200 words describing the significance and benefits of feeding children nutritious foods this healthy food essay

essay on healthy food in english english summary - Mar 29 2022