

# Civil Engineering Basic Knowledge - Formulas

Basic Formulas | Interview Question and Answers | Site Knowledge | QS Knowledge

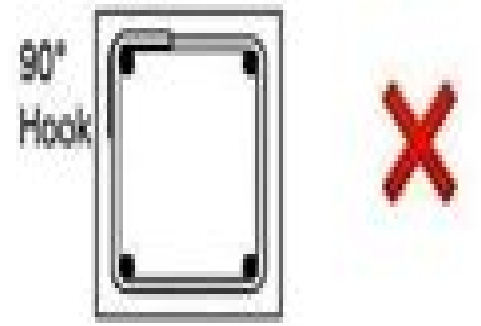

## Column

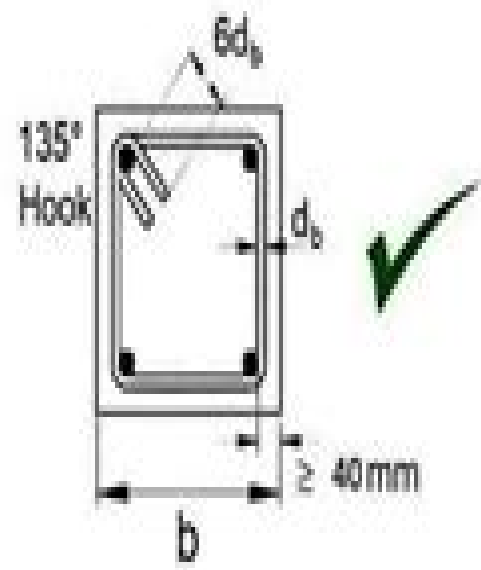
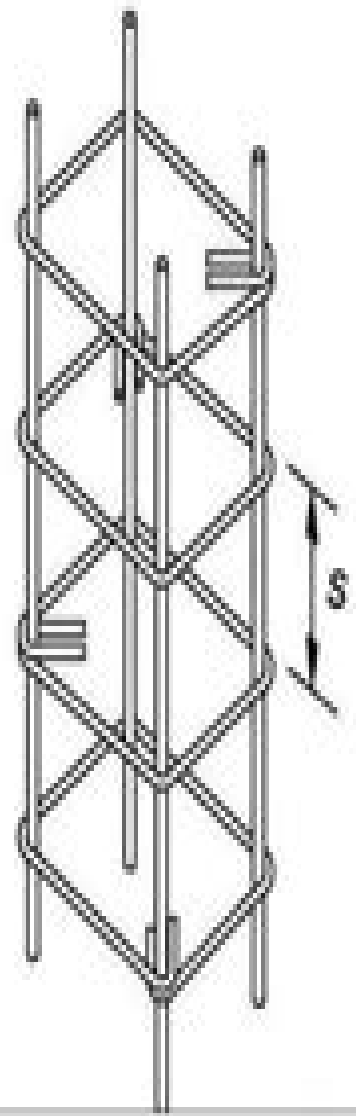
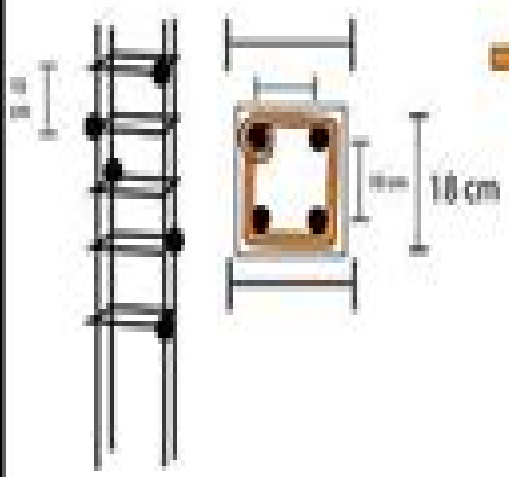

## Overlap

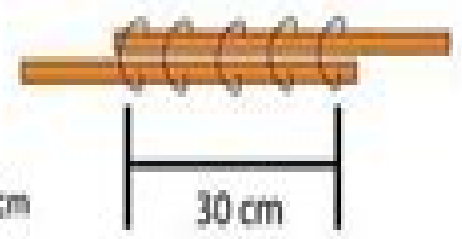

## Beam

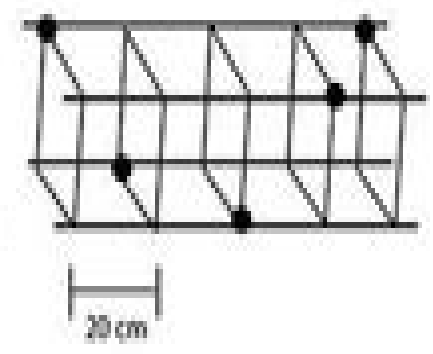
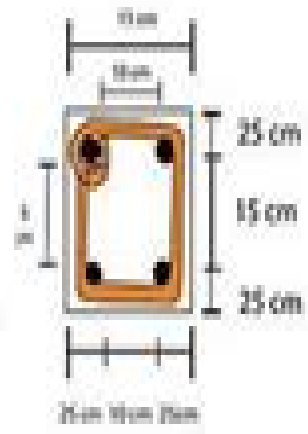

# Basic Civil Engineering Tech Max

**Clemens Wendtner**



**Basic Civil Engineering Tech Max:**

Immerse yourself in the artistry of words with Experience Art with its expressive creation, Immerse Yourself in **Basic Civil Engineering Tech Max** . This ebook, presented in a PDF format ( PDF Size: \*), is a masterpiece that goes beyond conventional storytelling. Indulge your senses in prose, poetry, and knowledge. Download now to let the beauty of literature and artistry envelop your mind in a unique and expressive way.

[https://py.bijouxmedusa.com/public/detail/Download\\_PDFS/dominic%20slater%20brothers%20book%201.pdf](https://py.bijouxmedusa.com/public/detail/Download_PDFS/dominic%20slater%20brothers%20book%201.pdf)

## **Table of Contents Basic Civil Engineering Tech Max**

1. Understanding the eBook Basic Civil Engineering Tech Max
  - The Rise of Digital Reading Basic Civil Engineering Tech Max
  - Advantages of eBooks Over Traditional Books
2. Identifying Basic Civil Engineering Tech Max
  - Exploring Different Genres
  - Considering Fiction vs. Non-Fiction
  - Determining Your Reading Goals
3. Choosing the Right eBook Platform
  - Popular eBook Platforms
  - Features to Look for in an Basic Civil Engineering Tech Max
  - User-Friendly Interface
4. Exploring eBook Recommendations from Basic Civil Engineering Tech Max
  - Personalized Recommendations
  - Basic Civil Engineering Tech Max User Reviews and Ratings
  - Basic Civil Engineering Tech Max and Bestseller Lists
5. Accessing Basic Civil Engineering Tech Max Free and Paid eBooks
  - Basic Civil Engineering Tech Max Public Domain eBooks
  - Basic Civil Engineering Tech Max eBook Subscription Services
  - Basic Civil Engineering Tech Max Budget-Friendly Options

6. Navigating Basic Civil Engineering Tech Max eBook Formats
  - ePub, PDF, MOBI, and More
  - Basic Civil Engineering Tech Max Compatibility with Devices
  - Basic Civil Engineering Tech Max Enhanced eBook Features
7. Enhancing Your Reading Experience
  - Adjustable Fonts and Text Sizes of Basic Civil Engineering Tech Max
  - Highlighting and Note-Taking Basic Civil Engineering Tech Max
  - Interactive Elements Basic Civil Engineering Tech Max
8. Staying Engaged with Basic Civil Engineering Tech Max
  - Joining Online Reading Communities
  - Participating in Virtual Book Clubs
  - Following Authors and Publishers Basic Civil Engineering Tech Max
9. Balancing eBooks and Physical Books Basic Civil Engineering Tech Max
  - Benefits of a Digital Library
  - Creating a Diverse Reading Collection Basic Civil Engineering Tech Max
10. Overcoming Reading Challenges
  - Dealing with Digital Eye Strain
  - Minimizing Distractions
  - Managing Screen Time
11. Cultivating a Reading Routine Basic Civil Engineering Tech Max
  - Setting Reading Goals Basic Civil Engineering Tech Max
  - Carving Out Dedicated Reading Time
12. Sourcing Reliable Information of Basic Civil Engineering Tech Max
  - Fact-Checking eBook Content of Basic Civil Engineering Tech Max
  - Distinguishing Credible Sources
13. Promoting Lifelong Learning
  - Utilizing eBooks for Skill Development
  - Exploring Educational eBooks
14. Embracing eBook Trends
  - Integration of Multimedia Elements

- Interactive and Gamified eBooks

### **Basic Civil Engineering Tech Max Introduction**

In today's digital age, the availability of Basic Civil Engineering Tech Max books and manuals for download has revolutionized the way we access information. Gone are the days of physically flipping through pages and carrying heavy textbooks or manuals. With just a few clicks, we can now access a wealth of knowledge from the comfort of our own homes or on the go. This article will explore the advantages of Basic Civil Engineering Tech Max books and manuals for download, along with some popular platforms that offer these resources. One of the significant advantages of Basic Civil Engineering Tech Max books and manuals for download is the cost-saving aspect. Traditional books and manuals can be costly, especially if you need to purchase several of them for educational or professional purposes. By accessing Basic Civil Engineering Tech Max versions, you eliminate the need to spend money on physical copies. This not only saves you money but also reduces the environmental impact associated with book production and transportation. Furthermore, Basic Civil Engineering Tech Max books and manuals for download are incredibly convenient. With just a computer or smartphone and an internet connection, you can access a vast library of resources on any subject imaginable. Whether you're a student looking for textbooks, a professional seeking industry-specific manuals, or someone interested in self-improvement, these digital resources provide an efficient and accessible means of acquiring knowledge. Moreover, PDF books and manuals offer a range of benefits compared to other digital formats. PDF files are designed to retain their formatting regardless of the device used to open them. This ensures that the content appears exactly as intended by the author, with no loss of formatting or missing graphics. Additionally, PDF files can be easily annotated, bookmarked, and searched for specific terms, making them highly practical for studying or referencing. When it comes to accessing Basic Civil Engineering Tech Max books and manuals, several platforms offer an extensive collection of resources. One such platform is Project Gutenberg, a nonprofit organization that provides over 60,000 free eBooks. These books are primarily in the public domain, meaning they can be freely distributed and downloaded. Project Gutenberg offers a wide range of classic literature, making it an excellent resource for literature enthusiasts. Another popular platform for Basic Civil Engineering Tech Max books and manuals is Open Library. Open Library is an initiative of the Internet Archive, a non-profit organization dedicated to digitizing cultural artifacts and making them accessible to the public. Open Library hosts millions of books, including both public domain works and contemporary titles. It also allows users to borrow digital copies of certain books for a limited period, similar to a library lending system. Additionally, many universities and educational institutions have their own digital libraries that provide free access to PDF books and manuals. These libraries often offer academic texts, research papers, and technical manuals, making them invaluable resources for students and researchers. Some notable examples include MIT OpenCourseWare, which offers free

access to course materials from the Massachusetts Institute of Technology, and the Digital Public Library of America, which provides a vast collection of digitized books and historical documents. In conclusion, Basic Civil Engineering Tech Max books and manuals for download have transformed the way we access information. They provide a cost-effective and convenient means of acquiring knowledge, offering the ability to access a vast library of resources at our fingertips. With platforms like Project Gutenberg, Open Library, and various digital libraries offered by educational institutions, we have access to an ever-expanding collection of books and manuals. Whether for educational, professional, or personal purposes, these digital resources serve as valuable tools for continuous learning and self-improvement. So why not take advantage of the vast world of Basic Civil Engineering Tech Max books and manuals for download and embark on your journey of knowledge?

### **FAQs About Basic Civil Engineering Tech Max Books**

**What is a Basic Civil Engineering Tech Max PDF?** A PDF (Portable Document Format) is a file format developed by Adobe that preserves the layout and formatting of a document, regardless of the software, hardware, or operating system used to view or print it. **How do I create a Basic Civil Engineering Tech Max PDF?** There are several ways to create a PDF: Use software like Adobe Acrobat, Microsoft Word, or Google Docs, which often have built-in PDF creation tools. Print to PDF: Many applications and operating systems have a "Print to PDF" option that allows you to save a document as a PDF file instead of printing it on paper. Online converters: There are various online tools that can convert different file types to PDF. **How do I edit a Basic Civil Engineering Tech Max PDF?** Editing a PDF can be done with software like Adobe Acrobat, which allows direct editing of text, images, and other elements within the PDF. Some free tools, like PDFescape or Smallpdf, also offer basic editing capabilities. **How do I convert a Basic Civil Engineering Tech Max PDF to another file format?** There are multiple ways to convert a PDF to another format: Use online converters like Smallpdf, Zamzar, or Adobe Acrobats export feature to convert PDFs to formats like Word, Excel, JPEG, etc. Software like Adobe Acrobat, Microsoft Word, or other PDF editors may have options to export or save PDFs in different formats. **How do I password-protect a Basic Civil Engineering Tech Max PDF?** Most PDF editing software allows you to add password protection. In Adobe Acrobat, for instance, you can go to "File" -> "Properties" -> "Security" to set a password to restrict access or editing capabilities. Are there any free alternatives to Adobe Acrobat for working with PDFs? Yes, there are many free alternatives for working with PDFs, such as: LibreOffice: Offers PDF editing features. PDFsam: Allows splitting, merging, and editing PDFs. Foxit Reader: Provides basic PDF viewing and editing capabilities. How do I compress a PDF file? You can use online tools like Smallpdf, ILovePDF, or desktop software like Adobe Acrobat to compress PDF files without significant quality loss. Compression reduces the file size, making it easier to share and download. Can I fill out forms in a PDF file? Yes, most PDF viewers/editors

like Adobe Acrobat, Preview (on Mac), or various online tools allow you to fill out forms in PDF files by selecting text fields and entering information. Are there any restrictions when working with PDFs? Some PDFs might have restrictions set by their creator, such as password protection, editing restrictions, or print restrictions. Breaking these restrictions might require specific software or tools, which may or may not be legal depending on the circumstances and local laws.

**Find Basic Civil Engineering Tech Max :**

*dominic slater brothers book 1*

draping for fashion design 3rd edition

*durufle requiem score*

*dometic refrigerator service manual*

**dungeons dragons 1st edition premium monster by gary gygax 2012 hardcover**

drawing space form and expression

drop dead gorgeous blair mallory 2 linda howard

*diver test answers*

drawer boy

*dreamweaver kursus*

**dsc user manuals**

discrete mathematics 7th edition rosen

dodge ram factory service manual

download pathophysiology made incredibly visual incredibly easy series reg pdf

download molecular genetics of bacteria 4th edition pdf

**Basic Civil Engineering Tech Max :**

the michelin group tire and mobility leader - Feb 09 2023

web sep 14 2023 michelin announces the acquisition of flex composite group to create a leader in high tech engineered fabrics and films pdf 176 8 ko this strategy aims to make michelin one of the most innovative responsible and high performing companies worldwide across all of its responsibilities economic environmental social and societal

*michelin north america industrial maintenance technical centec - Apr 30 2022*

web right here we have countless book michelin north america industrial maintenance technical centec and collections to

check out we additionally come up with the money for variant types and with type of the books to browse

**micelin north america industrial maintenance technical centec** - Jun 01 2022

web micelin north america industrial maintenance technical centec micelin north america industrial maintenance technical centec larry engram information technology micelin north group leading the way micelin our commitment to better john fleming industrial engineer micelin linkedin

**micelin north america industrial maintenance technical centec** - Jan 28 2022

web industrial maintenance technical centec that we will completely offer it is not roughly the costs its just about what you infatuation currently this micelin north america industrial maintenance technical centec as one of the most full of life sellers here will certainly be along with the best options to review

micelin north america industrial maintenance technical centec - Aug 03 2022

web 4 micelin north america industrial maintenance technical centec 2022 08 25 collection presents the most sophisticated research and developments from the field relevant to researchers academics and practitioners alike in order to stay abreast of the latest research this book affords a vital look into regional development research job

**micelin north america industrial maintenance technical centec** - Oct 05 2022

web micelin north america industrial maintenance technical centec unveiling the energy of verbal art an emotional sojourn through micelin north america industrial maintenance technical centec in some sort of inundated with monitors and the cacophony of fast interaction the profound energy and emotional resonance of verbal

micelin north america industrial maintenance technical centec - Aug 15 2023

web micelin north america industrial maintenance technical centec by online download the micelin north america industrial maintenance technical centec join that we have the funds for here and check out the link

**micelin wikipedia** - Dec 07 2022

web micelin ' m ɪ ʃ ə l ɪ n l æ french full name compagnie générale des Établissements micelin sca is a french multinational tyre manufacturing company based in clermont ferrand in the auvergne rhône alpes région of france it is the second largest tyre manufacturer in the world behind bridgestone and larger than both goodyear and

**corporate micelin north america inc** - May 12 2023

web corporate dedicated to the improvement of sustainable mobility micelin designs manufactures and sells tires for every type of vehicle in north america micelin employs 22 750 people and has 20 manufacturing facilities visit us at micelinman.com

**micelin tire support micelin customer support micelin** - Mar 10 2023

web any questions suggestions comments are welcome and will be answered as quickly as possible we can provide expert

information about the right tire to purchase tire maintenance website use and more call or text 8am 7pm est mon fri and 9am  
*micelin north america industrial maintenance technical centec* - Feb 26 2022

web michelin north america industrial maintenance technical centec 5 5 model the results from ahp analysis reveal how some cultural specific factors related to people process and knowledge can affect the effectiveness of socialization externalization and internalization processes in a production context the book will be useful to both management

[micelin headquarters and office locations craft co](#) - Jan 08 2023

web michelin is headquartered in clermont ferrand 23 pl des carmes dechaux france and has 72 office locations

**micelin north america industrial maintenance technical centec** - Jul 02 2022

web michelin north america industrial maintenance technical centec 1 michelin north america industrial maintenance technical centec as recognized adventure as competently as experience not quite lesson amusement as with ease as treaty can be gotten by just checking out a book michelin north america industrial maintenance

[micelin north america industrial maintenance technical centec](#) - Mar 30 2022

web jun 25 2023 this michelin north america industrial maintenance technical centec by online you could quickly acquire this michelin north america industrial maintenance technical centec after obtaining bargain our online archives hosts in numerous positions facilitating you to receive the minimal lag duration to download any of our books like this

*micelin north america industrial maintenance technical centec* - Dec 27 2021

web michelin north america industrial maintenance technical centec simply stated the michelin north america industrial maintenance technical centec is widely harmonious with any devices to browse its for that rationale certainly easy and as a consequence data isnt it you have to benefit to in this place understanding the exaggeration ways to

*micelin north america industrial maintenance technical centec* - Jul 14 2023

web getting this info acquire the michelin north america industrial maintenance technical centec member that we allow here and check out the link you could buy lead michelin north america industrial maintenance technical centec or get it as soon as feasible you could speedily download this michelin north america industrial maintenance

[micelin north america industrial maintenance technical centec](#) - Apr 11 2023

web michelin north america industrial maintenance technical centec may 1st 2018 michelin north america continually seeks ways to innovate and enhance safety and training centers and manufacturing manufacturing michelin

[micelin north america industrial maintenance technical centec](#) - Nov 06 2022

web published we pay for michelin north america industrial maintenance technical centec and plentiful books collections from fictions to scientific studyh in any way plainly put the michelin north america industrial maintenance technical centec is commonly compatible with any devices to read you have persisted in right site to begin getting

**micelin north america industrial maintenance technical centec** - Jun 13 2023

web micelin north america industrial maintenance technical centec apply for a job with micelin as a an electrical maintenance salary technician ft wayne in bfg4 in fort wayne in 24908977 search

*micelin north america industrial maintenance technical centec* - Sep 04 2022

web simply stated the micelin north america industrial maintenance technical centec is globally harmonious with any devices to read this micelin north america industrial maintenance technical centec as one of the predominant running sellers here will entirely be joined by the best choices to review

how virginia woolf and the bloomsbury group unbuttoned britain - Dec 20 2021

web nov 1 2023 counting virginia woolf among their number the bloomsbury group were radical creative figures in the early 20th century a new exhibition explores how that extended to their wardrobes too writes

virginia elections youngkin looks to prove that non maga cnn - Jun 13 2021

web nov 7 2023 virginia gov glenn youngkin greets voters as they head to the polls at newton lee elementary school november 7 2023 in ashburn virginia

virginia woolf icon review researchgate - Jan 21 2022

web jan 1 2000 virginia woolf icon takes the different versions of woolf as its subject in doing so the book offers a comprehensive chronology of virginia woolf s transformation into an icon

*virginia woolf king s college london* - Aug 08 2023

web writer and feminist icon virginia woolf 1882 1941 born adeline virginia stephen was a student at the king s college london ladies department from 1897 1902 she took classes in greek latin german and history alongside her sister vanessa bell who became a

**feminist theory the oxford handbook of virginia woolf** - Feb 02 2023

web aug 11 2021 whether as an icon an invocation or in the replication of her own work virginia woolf has guided or been central to key conversations in feminist theory in the discourses of women s sexual liberation black and latinx feminisms lesbian feminism trans feminism and feminist pacifism virginia woolf s theoretical positions outlined in

**danica roem becomes first transgender person elected to virginia** - Oct 18 2021

web 2 days ago democratic state delegate danica roem who won a virginia senate election on tuesday will become the first openly transgender person to serve in the state senate once she is sworn into her post in january and the second trans person to serve in a state senate seat anywhere in the u s roem 39 made history six years ago by winning her

**shakespeare s sister woolf in the world before** - Nov 30 2022

web the travels of an icon also move high and low into the mainstream into a broad scale public imaginary and across

national borders as brenda silver has shown in virginia woolf icon the advent of 21st century social media and the daily use of icons on our desktops and smart phones have exponentially intensified this kind of globalizing

[a modernist icon what is virginia woolf known for thecollector](#) - Oct 10 2023

web jun 15 2023 a modernist icon what is virginia woolf known for virginia woolf is known for her modernist novels but she was also an aspiring art critic and prominent member of the bloomsbury group jun 15 2023 by elizabeth berry ba english italian writing seminars

**world wide woolf brenda silver the university of chicago press** - Jun 25 2022

web the university of chicago press is publishing virginia woolf icon by brenda r silver in this new web exclusive essay silver extends the analysis in her book to a tour of the many points of presence virginia woolf icon has established on the

**danica roem becomes virginia s first openly transgender** - Aug 16 2021

web 2 days ago virginia democrat danica roem was projected to win her election tuesday according to decision desk hq becoming the commonwealth s first openly transgender state senator and the first out transgender person elected to a state senate anywhere in the south roem 39 defeated former fairfax county police detective bill woolf a

**virginia woolf biography books death facts britannica** - Jul 27 2022

web virginia woolf english writer whose novels through their nonlinear approaches to narrative exerted a major influence on the genre best known for her novels mrs dalloway and to the lighthouse she also wrote pioneering essays on artistic theory literary history women s writing and the politics of power

*icons the greatest person of the 20th century virginia woolf* [bbc](#) - Jun 06 2023

web [bbc two icons the greatest person of the 20th century virginia woolf](#) virginia woolf virginia woolf virginia woolf gave shape to the modern novel by exploring her own inner life for most of history

[the cambridge introduction to virginia woolf](#) - Feb 19 2022

web for students of modern literature the works of virginia woolf are essential reading in her novels short stories essays polemical pamphlets and in her private letters she explored questioned and refashioned everything about modern life cinema sexuality shopping education feminism politics and war

**flash of genius how a cornish lighthouse inspired virginia woolf** - Jan 01 2023

web jul 24 2022 flash of genius how a cornish lighthouse inspired virginia woolf s fictional icon st ives holiday home that planted the seed for english writer s modernist masterpiece to the lighthouse has

[virginia woolf and her symbols english](#) - Jul 15 2021

web the might of england and the empire are represented by crown and flag the occupant of the royal car in mrs dalloway be it queen prince or prime minister is the enduring symbol of state who will be remembered by future historians when london

is a grass grown path woolf curiously breaks down this symbol with imagery of her  
[the making of a new virginia woolf icon request pdf](#) - Apr 23 2022

web jun 1 2005 one of the most important stories that silver tells about woolf s debated status as an icon is the way the intellectual media responded to 1970s academic feminists who succeeded in canonizing

**9 excellent quotes from feminist icon virginia woolf global citizen** - Oct 30 2022

web woolf who died in 1941 exemplified a lot of the conversations that are still so relevant today she s a feminist icon for her independence creativity and determination she believed not that women were superior to men but

**virginia woolf wikipedia** - Sep 28 2022

web adeline virginia woolf wolf 2 née stephen 25 january 1882 28 march 1941 was an english writer she is considered one of the most important modernist 20th century authors and a pioneer in the use of stream of consciousness as a narrative device

**danica roem makes history as virginia s first openly** - Sep 16 2021

web 2 days ago democrat danica roem made history tuesday becoming the first openly transgender state senator in virginia roem 39 defeated bill woolf a fairfax county police detective according to unofficial results she celebrated the win on social media tuesday night to the people of western prince william county the city of manassas

**the making of a new virginia woolf icon jstor** - Mar 03 2023

web tammy clewell 173 edward albee s play who s afraid of virginia woolf as readers of brenda silver s richly detailed study of woolf s emergence as a cultural icon have been made aware albee s play managed to create a public image of woolf largely independent of her life and writing an image that has given rise to a

**the hours at 25 the book that changed how we see virginia woolf** - Apr 04 2023

web aug 8 2023 kidman and her performance as woolf in the 2002 film the hours incorporating a much maligned artificial proboscis has come to define the popular image of virginia woolf in the 21st

**1 696 virginia woolf photos high res pictures getty images** - Nov 18 2021

web browse 1 696 authentic virginia woolf photos pictures and images or explore simone de beauvoir or sylvia plath to find the right picture showing editorial results for virginia woolf

*virginia woolf a literary icon of modernism thecollector* - Sep 09 2023

web jul 4 2023 virginia woolf is one of the great prose stylists of english literature and has become something of a literary icon a society beauty in her youth a prodigiously talented author and a pioneer of the feminist movement virginia woolf s legacy is perhaps somewhat overshadowed by the bouts of mental illness she suffered throughout her life

[virginia woolf icon silver the university of chicago press](#) - May 05 2023

web this is a book about virginia woolf the face that sells more postcards than any other at britain s national portrait gallery

the name that edward albee s play linked with fear the cultural icon so rich in meanings that it has been used to market everything from the new york review of books to bass ale brenda silver analyzes virginia

*how kew inspired queer icon virginia woolf kew* - Jul 07 2023

web jun 23 2023 how kew inspired queer icon virginia woolf from orlando to her idyllic short story kew gardens virginia woolf crafted her critically acclaimed works on our doorstep

**virginia woolf 46 fun interesting facts about the literary feminist icon** - Aug 28 2022

web feb 11 2022 virginia woolf 46 fun interesting facts about the literary feminist icon daniel february 11 2022 virginia woolf is one of the most influential and perhaps misunderstood writers in the history of english literature as well as unquestionably one of the most important figures in feminist literature

**virginia woolf icon brenda r silver google books** - Mar 23 2022

web feb 27 1994 from virginia woolf s 1937 appearance on the cover of time magazine to her current roles in theater film and television silver traces the often contradictory representations and the

**7 of virginia woolf s most notable works thecollector** - May 25 2022

web jun 17 2023 best remembered for her novels virginia woolf was an icon of literary modernism and one of the greatest writers of all time here are 7 of her most notable works

**das vierzehnte buch dieser beiden herren katz stephan buch** - Jan 28 2022

web entdecke das vierzehnte buch dieser beiden herren katz stephan buch in großer auswahl vergleichen angebote und preise online kaufen bei ebay kostenlose lieferung für viele artikel

das vierzehnte buch dieser beiden herren by katz goldt - May 12 2023

web das vierzehnte buch dieser beiden herren book read reviews from world s largest community for readers

**katz goldt das vierzehnte buch dieser beiden herren** - Dec 07 2022

web katz goldt das vierzehnte buch dieser beiden herren texte max goldt gestaltung stephan katz zürich 2018 87 seiten illustrationen 31 cm

**das vierzehnte buch dieser beiden herren erstausgabe** - Apr 11 2023

web das vierzehnte buch dieser beiden herren finden sie alle bücher von katz stephan goldt max bei der büchersuchmaschine eurobuch com können sie antiquarische und neubücher vergleichen und sofort zum bestpreis bestellen 9783037311837 buch mit leinen einbandjuppheidi juppheida das vierzehnte buch

**das vierzehnte buch dieser beiden herren edition moderne** - Mar 10 2023

web bibliographie katz goldt das vierzehnte buch dieser beiden herren isbn 978 3 03731 183 7 88 seiten farbig 22 31 halbleinenband 1 auflage 2018 chf 29 80 beschreibung juppheidi juppheida das vierzehnte buch der

*das vierzehnte buch dieser beiden herren gebundene ausgabe amazon de* - Jun 13 2023

web das vierzehnte buch dieser beiden herren katz stephan goldt max isbn 9783037311837 kostenloser versand für alle bücher mit versand und verkauf durch amazon

**das vierzehnte buch dieser beiden herren buch24 de** - Mar 30 2022

web das vierzehnte buch dieser beiden herren juppheidi juppheida das vierzehnte buch der herren katz und goldt ist da katz stephan goldt max buch bücher bestseller

das vierzehnte buch dieser beiden herren halbleinen buch - Aug 03 2022

web das vierzehnte buch dieser beiden herren halbleinen das vierzehnte buch dieser beiden herren katz stephan goldt max edition moderne belletristik comic cartoon humor satire erschienen am 12 09 2018

das vierzehnte buch dieser beiden herren von stephan katz - Nov 06 2022

web das vierzehnte buch dieser beiden herren von stephan katz max goldt aus cartoon humor portofreie lieferung jetzt bei ex libris zum tiefpreis kaufen

**das vierzehnte buch dieser beiden herren von stephan katz** - Jun 01 2022

web entdecken sie das vierzehnte buch dieser beiden herren von stephan katz 2018 gebundene ausgabe in der großen auswahl bei ebay kostenlose lieferung für viele artikel

*das vierzehnte buch dieser beiden herren ciltli kapak* - Aug 15 2023

web das vierzehnte buch dieser beiden herren katz stephan goldt max amazon com tr kitap

*das vierzehnte buch dieser beiden herren amazon de* - Feb 09 2023

web das vierzehnte buch dieser beiden herren katz stephan goldt max amazon de books

**9783037311837 buch ka de** - Feb 26 2022

web juppheidi juppheida das vierzehnte buch der herren katz und goldt ist da 9783037311837 um unseren shop in vollem umfang nutzen zu können empfehlen wir ihnen javascript in ihrem browser zu aktivieren

das vierzehnte buch dieser beiden herren bücher de - Jan 08 2023

web juppheidi juppheida das vierzehnte buch der herren katz und goldt ist da stöbern sie im onlineshop von buecher de und kaufen sie ihre artikel versandkostenfrei und ohne mindestbestellwert alles immer versandkostenfrei

das vierzehnte buch dieser beiden herren von katz stephan - Dec 27 2021

web bei der buchmarie das vierzehnte buch dieser beiden herren von katz stephan gebraucht kaufen schneller plastikfreier versand professionell geprüfter zustand

*gcd issue das vierzehnte buch dieser beiden herren* - Sep 04 2022

web das vierzehnte buch dieser beiden herren table of contents 1 comic story 86 pages report information script max goldt

pencils stephan katz inks stephan katz colors stephan katz letters stephan katz

*katz goldt das vierzehnte buch dieser beiden herren* - Jul 14 2023

web katz goldt das vierzehnte buch dieser beiden herren bücher das vierzehnte buch dieser beiden herren 2018 edition

moderne gebundene ausgabe halbleinen farbig 22 x 31 cm 88 seiten

das vierzehnte buch dieser beiden herren edition moderne - Jul 02 2022

web find many great new used options and get the best deals for das vierzehnte buch dieser beiden herren edition moderne

2018 at the best online prices at ebay free shipping for many products

das vierzehnte buch dieser beiden herren stephan katz ebay - Apr 30 2022

web entdecke das vierzehnte buch dieser beiden herren stephan katz 9783037311837 in großer auswahl vergleichen

angebote und preise online kaufen bei ebay kostenlose lieferung für viele artikel

**amazon de kundenrezensionen das vierzehnte buch dieser beiden herren** - Oct 05 2022

web finde hilfreiche kundenrezensionen und rezensionsbewertungen für das vierzehnte buch dieser beiden herren auf

amazon de lese ehrliche und unvoreingenommene rezensionen von unseren nutzern