

**ME 1020: ENGINEERING PROGRAMMING WITH MATLAB
 FINAL EXAM**

Open Book, Closed Notes, Do Not Write on this Sheet
Create a Separate MATLAB Script File for Each Problem
Submit all MATLAB files (.m) to Dr. Thomas
Each MATLAB File Must Have the Following Header:

```
1 % Final Exam, ME 1020, Spring 2016, Your Name Here
2 clc, clear all, close all
```

Problem 1 (4 Points): Create a MATLAB script file to calculate and plot the derivative of the function $y(x) = e^{-x} \sin(3x)$ from $0 \leq x \leq 4$ using the Forward Difference Method described in class (shown below). You must use a for loop to solve this problem. Provide a plot title and labels for the axes. Use 101 points from $x = 0$ to $x = 4$.

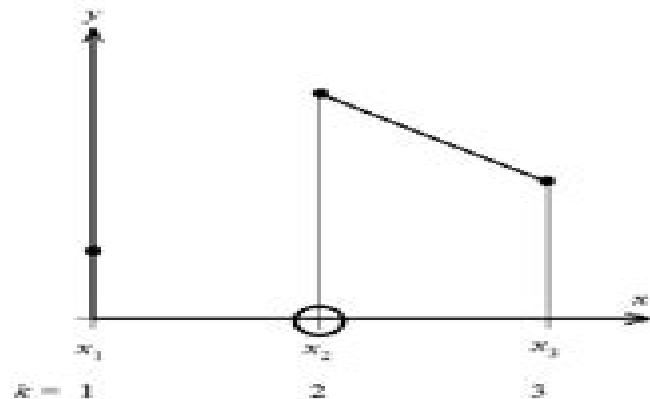

$$\left. \frac{dy}{dx} \right|_{x_2} = \frac{y_3 - y_2}{x_3 - x_2}$$

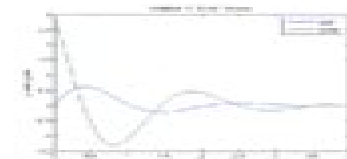

Problem 2 (4 Points): Create a MATLAB script file to calculate and plot the integral of the function $y(x) = e^{-x} \sin(3x)$ from $0 \leq x \leq 4$ using the Trapezoidal Method described in class (shown below). You must use a for loop to solve this problem. Provide a plot title and labels for the axes. Use 101 points from $x = 0$ to $x = 4$.

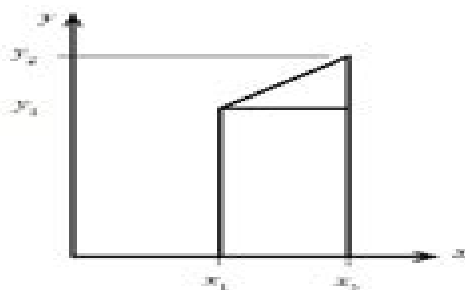

$$A_{\text{trapezoid}} = \frac{1}{2} (x_2 - x_1) (y_1 + y_2)$$

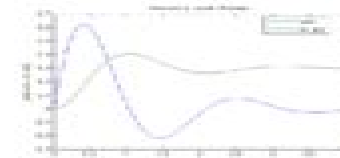

Matlab Final Exam And Answers

VM Jensen



Matlab Final Exam And Answers:

Introduction to Computational Science Angela B. Shiflet, George W. Shiflet, 2014-03-30 The essential introduction to computational science now fully updated and expanded Computational science is an exciting new field at the intersection of the sciences computer science and mathematics because much scientific investigation now involves computing as well as theory and experiment This textbook provides students with a versatile and accessible introduction to the subject It assumes only a background in high school algebra enables instructors to follow tailored pathways through the material and is the only textbook of its kind designed specifically for an introductory course in the computational science and engineering curriculum While the text itself is generic an accompanying website offers tutorials and files in a variety of software packages This fully updated and expanded edition features two new chapters on agent based simulations and modeling with matrices ten new project modules and an additional module on diffusion Besides increased treatment of high performance computing and its applications the book also includes additional quick review questions with answers exercises and individual and team projects The only introductory textbook of its kind now fully updated and expanded Features two new chapters on agent based simulations and modeling with matrices Increased coverage of high performance computing and its applications Includes additional modules review questions exercises and projects An online instructor s manual with exercise answers selected project solutions and a test bank and solutions available only to professors An online illustration package is available to professors

MATLAB Numerical Methods with Chemical Engineering Applications Kamal I. M. Al-Malah, 2013-07-31 A practical professional guide to MATLAB computational techniques and engineering applications MATLAB Numerical Methods with Chemical Engineering Applications shows you step by step how to use MATLAB to model and simulate physical problems in the chemical engineering realm Written for MATLAB 7 11 this hands on resource contains concise explanations of essential MATLAB commands as well as easy to follow instructions for using the programming features graphical capabilities and desktop interface Every step needed toward the final solution is algorithmically explained via snapshots of the MATLAB platform in parallel with the text End of chapter problems help you practice what you ve learned Master this powerful computational tool using this detailed self teaching guide **COVERAGE INCLUDES** MATLAB basics Matrices MATLAB scripting language M file Image and image analysis Curve fitting Numerical integration Solving differential equations A system of algebraic equations Statistics Chemical engineering applications MATLAB Graphical User Interface Design Environment **GUIDE** Linear Systems and Signals Bhagwandas Pannalal Lathi, 2010 Incorporating new problems and examples the second edition of Linear Systems and Signals features MATLAB material in each chapter and at the back of the book It gives clear descriptions of linear systems and uses mathematics not only to prove axiomatic theory but also to enhance physical and intuitive understanding Learner-Centered Design of Computing Education Mark Guzdial, 2022-05-31 Computing education is in enormous demand Many students both children and adult are realizing that

they will need programming in the future This book presents the argument that they are not all going to use programming in the same way and for the same purposes What do we mean when we talk about teaching everyone to program When we target a broad audience should we have the same goals as computer science education for professional software developers How do we design computing education that works for everyone This book proposes use of a learner centered design approach to create computing education for a broad audience It considers several reasons for teaching computing to everyone and how the different reasons lead to different choices about learning goals and teaching methods The book reviews the history of the idea that programming isn't just for the professional software developer It uses research studies on teaching computing in liberal arts programs to graphic designers to high school teachers in order to explore the idea that computer science for everyone requires us to re think how we teach and what we teach The conclusion describes how we might create computing education for everyone

Mathematics Education in the Age of Artificial Intelligence

Philippe R. Richard, M. Pilar Vélez, Steven Van Vaerenbergh, 2022-03-09 This book highlights the contribution of artificial intelligence for mathematics education It provides concrete ideas supported by mathematical work obtained through dynamic international collaboration and discusses the flourishing of new mathematics in the contemporary world from a sustainable development perspective Over the past thirty years artificial intelligence has gradually infiltrated all facets of society When it is deployed in interaction with the human designer or user AI certainly raises new ethical questions But as soon as it aims to augment intelligence in a kind of human machine partnership it goes to the heart of knowledge development and the very performance of work The proposed themes and the sections of the book address original issues relating to the creation of AI milieus to work on mathematics to the AI supported learning of mathematics and to the coordination of usual paper pencil techniques and new AI aided educational working spaces The authors of the book and the coordinators of each section are all established specialists in mathematics didactics mathematics and computer science In summary this book is a must read for everyone interested in the teaching and learning of mathematics and it concerns the interaction between the human and the machine in both directions It contains ideas questions and inspiration that invite to take up the challenge of Artificial Intelligence contributing to Mathematical Human Learning

13th International Symposium on Process Systems Engineering - PSE 2018, July 1-5 2018 Mario R. Eden, Gavin Towler, Maria Ierapetritou, 2018-07-19 Process Systems Engineering brings together the international community of researchers and engineers interested in computing based methods in process engineering This conference highlights the contributions of the PSE community towards the sustainability of modern society and is based on the 13th International Symposium on Process Systems Engineering PSE 2018 event held San Diego CA July 1 5 2018 The book contains contributions from academia and industry establishing the core products of PSE defining the new and changing scope of our results and future challenges Plenary and keynote lectures discuss real world challenges globalization energy environment and health and contribute to

discussions on the widening scope of PSE versus the consolidation of the core topics of PSE Highlights how the Process Systems Engineering community contributes to the sustainability of modern society Establishes the core products of Process Systems Engineering Defines the future challenges of Process Systems Engineering **Innovations in E-learning, Instruction Technology, Assessment and Engineering Education** Magued Iskander,2007-09-04 This book includes a set of rigorously reviewed world class manuscripts addressing and detailing state of the art research projects in the areas of Engineering Education Instructional Technology Assessment and E learning The book presents selected papers form the conference proceedings of the International Conference on Engineering Education Instructional Technology Assessment and E learning EIAE 2006 All aspects of the conference were managed on line Modern Mathematics Education for Engineering Curricula in Europe Seppo Pohjolainen,Tuomas Myllykoski,Christian Mercat,Sergey Sosnovsky,2018-07-16 This open access book provides a comprehensive overview of the core subjects comprising mathematical curricula for engineering studies in five European countries and identifies differences between two strong traditions of teaching mathematics to engineers The collective work of experts from a dozen universities critically examines various aspects of higher mathematical education The two EU Tempus IV projects MetaMath and MathGeAr investigate the current methodologies of mathematics education for technical and engineering disciplines The projects aim to improve the existing mathematics curricula in Russian Georgian and Armenian universities by introducing modern technology enhanced learning TEL methods and tools as well as by shifting the focus of engineering mathematics education from a purely theoretical tradition to a more applied paradigm MetaMath and MathGeAr have brought together mathematics educators TEL specialists and experts in education quality assurance form 21 organizations across six countries The results of a comprehensive comparative analysis of the entire spectrum of mathematics courses in the EU Russia Georgia and Armenia has been conducted have allowed the consortium to pinpoint and introduce several modifications to their curricula while preserving the generally strong state of university mathematics education in these countriesThe book presents the methodology procedure and results of this analysis This book is a valuable resource for teachers especially those teaching mathematics and curriculum planners for engineers as well as for a general audience interested in scientific and technical higher education **43rd AIAA Aerospace Sciences Meeting & Exhibit** ,2005 **Nonlinear Industrial Control Systems** Michael J. Grimble,Pawel Majecki,2020-05-19 Nonlinear Industrial Control Systems presents a range of mostly optimisation based methods for severely nonlinear systems it discusses feedforward and feedback control and tracking control systems design The plant models and design algorithms are provided in a MATLAB toolbox that enable both academic examples and industrial application studies to be repeated and evaluated taking into account practical application and implementation problems The text makes nonlinear control theory accessible to readers having only a background in linear systems and concentrates on real applications of nonlinear control It covers different ways of modelling nonlinear systems including state space polynomial

based linear parameter varying state dependent and hybrid design techniques for nonlinear optimal control including generalised minimum variance model predictive control quadratic Gaussian factorised and H design methods design philosophies that are suitable for aerospace automotive marine process control energy systems robotics servo systems and manufacturing steps in design procedures that are illustrated in design studies to define cost functions and cope with problems such as disturbance rejection uncertainties and integral wind up and baseline non optimal control techniques such as nonlinear Smith predictors feedback linearization sliding mode control and nonlinear PID Nonlinear Industrial Control Systems is valuable to engineers in industry dealing with actual nonlinear systems It provides students with a comprehensive range of techniques and examples for solving real nonlinear control design problems

Elements of Engineering Probability and Statistics Rodger E. Ziemer, 1997 Responding to the needs of graduate engineers and ABET criteria this volume illustrates the essentials of both probability and statistics through computer exercises It features a wealth of computer exercises that provide experimental verification of probabilistic phenomena and a means for calculating and displaying complex results Government Reports Announcements & Index ,1992 **Annual Conference & Exposition** American Society for Engineering Education, 2005 Proceedings ,2005 Mathematics Today ,2000 Journal of Engineering Education ,2006 **Cornell University Courses of Study** Cornell University, 2003 Real-time Systems Education III Jerzy Nawrocki, Jean-Jacques Schwarz, Janusz Zalewski, 1999 Poznan Poland was selected as the site of the third annual workshop on this topic to coincide with the Software Engineering Education Symposium SEES 98 and also to establish an international presence in Central Europe although we are not an event on the scale of olympic games Twenty six participants pictured present papers related to real time systems programs and curricula teaching RT systems design and verification components of RT labs RT systems in control engineering education and in other disciplines Also includes invited talks on RT devices at practical prices and the essentials of RT education For the uninitiated IEEE stands for the Institute of Electrical and Electronic Engineers Author index only Annotation copyrighted by Book News Inc Portland OR

Communication & Cognition ,2006 **Windows Magazine** ,1999

Yeah, reviewing a book **Matlab Final Exam And Answers** could add your near links listings. This is just one of the solutions for you to be successful. As understood, exploit does not suggest that you have fabulous points.

Comprehending as well as concord even more than extra will manage to pay for each success. next to, the broadcast as skillfully as sharpness of this Matlab Final Exam And Answers can be taken as without difficulty as picked to act.

<https://py.bijouxmedusa.com/files/uploaded-files/Documents/essential%20calculus%20early%20transcendentals%20solution%20manual%20pdf.pdf>

Table of Contents Matlab Final Exam And Answers

1. Understanding the eBook Matlab Final Exam And Answers
 - The Rise of Digital Reading Matlab Final Exam And Answers
 - Advantages of eBooks Over Traditional Books
2. Identifying Matlab Final Exam And Answers
 - Exploring Different Genres
 - Considering Fiction vs. Non-Fiction
 - Determining Your Reading Goals
3. Choosing the Right eBook Platform
 - Popular eBook Platforms
 - Features to Look for in an Matlab Final Exam And Answers
 - User-Friendly Interface
4. Exploring eBook Recommendations from Matlab Final Exam And Answers
 - Personalized Recommendations
 - Matlab Final Exam And Answers User Reviews and Ratings
 - Matlab Final Exam And Answers and Bestseller Lists
5. Accessing Matlab Final Exam And Answers Free and Paid eBooks
 - Matlab Final Exam And Answers Public Domain eBooks

- Matlab Final Exam And Answers eBook Subscription Services
- Matlab Final Exam And Answers Budget-Friendly Options
- 6. Navigating Matlab Final Exam And Answers eBook Formats
 - ePub, PDF, MOBI, and More
 - Matlab Final Exam And Answers Compatibility with Devices
 - Matlab Final Exam And Answers Enhanced eBook Features
- 7. Enhancing Your Reading Experience
 - Adjustable Fonts and Text Sizes of Matlab Final Exam And Answers
 - Highlighting and Note-Taking Matlab Final Exam And Answers
 - Interactive Elements Matlab Final Exam And Answers
- 8. Staying Engaged with Matlab Final Exam And Answers
 - Joining Online Reading Communities
 - Participating in Virtual Book Clubs
 - Following Authors and Publishers Matlab Final Exam And Answers
- 9. Balancing eBooks and Physical Books Matlab Final Exam And Answers
 - Benefits of a Digital Library
 - Creating a Diverse Reading Collection Matlab Final Exam And Answers
- 10. Overcoming Reading Challenges
 - Dealing with Digital Eye Strain
 - Minimizing Distractions
 - Managing Screen Time
- 11. Cultivating a Reading Routine Matlab Final Exam And Answers
 - Setting Reading Goals Matlab Final Exam And Answers
 - Carving Out Dedicated Reading Time
- 12. Sourcing Reliable Information of Matlab Final Exam And Answers
 - Fact-Checking eBook Content of Matlab Final Exam And Answers
 - Distinguishing Credible Sources
- 13. Promoting Lifelong Learning
 - Utilizing eBooks for Skill Development
 - Exploring Educational eBooks

14. Embracing eBook Trends

- Integration of Multimedia Elements
- Interactive and Gamified eBooks

Matlab Final Exam And Answers Introduction

In today's digital age, the availability of Matlab Final Exam And Answers books and manuals for download has revolutionized the way we access information. Gone are the days of physically flipping through pages and carrying heavy textbooks or manuals. With just a few clicks, we can now access a wealth of knowledge from the comfort of our own homes or on the go. This article will explore the advantages of Matlab Final Exam And Answers books and manuals for download, along with some popular platforms that offer these resources. One of the significant advantages of Matlab Final Exam And Answers books and manuals for download is the cost-saving aspect. Traditional books and manuals can be costly, especially if you need to purchase several of them for educational or professional purposes. By accessing Matlab Final Exam And Answers versions, you eliminate the need to spend money on physical copies. This not only saves you money but also reduces the environmental impact associated with book production and transportation. Furthermore, Matlab Final Exam And Answers books and manuals for download are incredibly convenient. With just a computer or smartphone and an internet connection, you can access a vast library of resources on any subject imaginable. Whether you're a student looking for textbooks, a professional seeking industry-specific manuals, or someone interested in self-improvement, these digital resources provide an efficient and accessible means of acquiring knowledge. Moreover, PDF books and manuals offer a range of benefits compared to other digital formats. PDF files are designed to retain their formatting regardless of the device used to open them. This ensures that the content appears exactly as intended by the author, with no loss of formatting or missing graphics. Additionally, PDF files can be easily annotated, bookmarked, and searched for specific terms, making them highly practical for studying or referencing. When it comes to accessing Matlab Final Exam And Answers books and manuals, several platforms offer an extensive collection of resources. One such platform is Project Gutenberg, a nonprofit organization that provides over 60,000 free eBooks. These books are primarily in the public domain, meaning they can be freely distributed and downloaded. Project Gutenberg offers a wide range of classic literature, making it an excellent resource for literature enthusiasts. Another popular platform for Matlab Final Exam And Answers books and manuals is Open Library. Open Library is an initiative of the Internet Archive, a non-profit organization dedicated to digitizing cultural artifacts and making them accessible to the public. Open Library hosts millions of books, including both public domain works and contemporary titles. It also allows users to borrow digital copies of certain books for a limited period, similar to a library lending system. Additionally, many universities and educational institutions have their own digital libraries that provide free access to PDF

books and manuals. These libraries often offer academic texts, research papers, and technical manuals, making them invaluable resources for students and researchers. Some notable examples include MIT OpenCourseWare, which offers free access to course materials from the Massachusetts Institute of Technology, and the Digital Public Library of America, which provides a vast collection of digitized books and historical documents. In conclusion, Matlab Final Exam And Answers books and manuals for download have transformed the way we access information. They provide a cost-effective and convenient means of acquiring knowledge, offering the ability to access a vast library of resources at our fingertips. With platforms like Project Gutenberg, Open Library, and various digital libraries offered by educational institutions, we have access to an ever-expanding collection of books and manuals. Whether for educational, professional, or personal purposes, these digital resources serve as valuable tools for continuous learning and self-improvement. So why not take advantage of the vast world of Matlab Final Exam And Answers books and manuals for download and embark on your journey of knowledge?

FAQs About Matlab Final Exam And Answers Books

How do I know which eBook platform is the best for me? Finding the best eBook platform depends on your reading preferences and device compatibility. Research different platforms, read user reviews, and explore their features before making a choice. Are free eBooks of good quality? Yes, many reputable platforms offer high-quality free eBooks, including classics and public domain works. However, make sure to verify the source to ensure the eBook credibility. Can I read eBooks without an eReader? Absolutely! Most eBook platforms offer web-based readers or mobile apps that allow you to read eBooks on your computer, tablet, or smartphone. How do I avoid digital eye strain while reading eBooks? To prevent digital eye strain, take regular breaks, adjust the font size and background color, and ensure proper lighting while reading eBooks. What the advantage of interactive eBooks? Interactive eBooks incorporate multimedia elements, quizzes, and activities, enhancing the reader engagement and providing a more immersive learning experience. Matlab Final Exam And Answers is one of the best book in our library for free trial. We provide copy of Matlab Final Exam And Answers in digital format, so the resources that you find are reliable. There are also many Ebooks of related with Matlab Final Exam And Answers. Where to download Matlab Final Exam And Answers online for free? Are you looking for Matlab Final Exam And Answers PDF? This is definitely going to save you time and cash in something you should think about.

Find Matlab Final Exam And Answers :

essential calculus early transcendentals solution manual pdf

[experiment 7 isolation of limonene from orange peels](#)

[environmental economics kolstad solutions pdf](#)

estudios sobre el amor jose ortega y gasset

[erwin kreyszig functional analysis solution manual](#)

[essentials of septorhinoplasty](#)

[essentials of conservation biology 5th edition](#)

[example risk assessment cold storage warehousing](#)

[equal is unfair americas misguided fight against income inequality](#)

[essential oil recipes top essential oil recipes for weight loss beauty anti aging natural cleaning natural living natural cures](#)

[and healthy essential oil recipe guide volume 1](#)

[evolve for pathophysiology test bank questions pdf](#)

experimental psychology 8th edition solso maclin

[famosas canciones para piano y mejores baladas partituras](#)

[ethos logos pathos and mythos adding mystery idsa](#)

english questions and answers for interviews full download

Matlab Final Exam And Answers :

commissioning and recording vocalessence - Jun 14 2023

web vocalessence music press a dynamic new music publishing company that offers a select group of emerging composers the opportunity to make their music available to choirs everywhere interested in commissioning music contact our executive director mary ann aufderheide 612 547 1454 or maryann vocalessence Org to learn more

[vocalessence 49th season fall concert program book](#) - Jun 02 2022

web sep 14 2017 the program also includes a performance by the professional vocalessence ensemble singers and possible commission and publication through vocalessence music press the 2017 vocalessence remix

[vocalessence facebook](#) - Nov 07 2022

web vocalessence 5 626 likes 47 talking about this vocalessence draws upon the power of singing together to nurture community together we sing

about vocalessence vocalessence - Jul 03 2022

web vocalessence music press a dynamic new music publishing company that offers a select group of emerging composers the opportunity to make their music available to choirs everywhere learn more about our mission vision values history

timeline

vocalessence youtube - Oct 06 2022

web vocalessence called one of the irreplaceable music ensembles of our time by former national endowment for the arts chairman dana gioia minneapolis based choral ensemble vocalessence has

a celebration of voices 2 more music from vocalessence music press - May 13 2023

web vocalessence music press is a dynamic music publishing company that offers a select group of emerging composers the opportunity to make their music available to choirs everywhere and we offer choruses access to new music they can t find anywhere else

works vocalessence music press publicaties sodexo nl - Mar 11 2023

web pages of works vocalessence music press a mesmerizing literary creation penned by a celebrated wordsmith readers embark on an enlightening odyssey unraveling the intricate significance of language and its enduring affect our lives

music press vocalessence - Aug 16 2023

web dec 22 2022 vocalessence music press is a dynamic music publishing company that offers a select group of emerging composers the opportunity to make their music available to choirs everywhere and we offer choruses access to

resources erik peregrine - Dec 08 2022

web vocalessence music press is a dynamic music publishing company that offers a select group of emerging composers the opportunity to make their music available to choirs everywhere discover cross cultural collaboration through the vocalessence cantaré series mexican composers wrote these works for minnesota school college and

coaches performance the voice 2021 youtube - Jan 29 2022

web scopri il metodo vocalessence vocalessencemethod comscrivi a info vocalessencemethod com per essere contattato da un membro specializzato vo

vocalessence cantaré series vocalessence - Feb 10 2023

web jul 25 2023 more than 60 new works have been commissioned and premiered through cantaré and from these works several newly published scores are now available to you through vocalessence music press through cantaré selected composers from mexico participate as artists in residence with elementary schools high schools colleges

works vocalessence music press secure4 khronos - Dec 28 2021

web stated the works vocalessence music press is internationally suitable with any devices to browse if you want to funny stories lots of literature tale gags and more fictions collections are also initiated from best seller to one of the most existing unveiled

en paz at peace graphite publishing - Apr 12 2023

web publisher vocalessence music press mixed choir difficulty 4 piano 5 10 min composer s jesús lópez moreno placid and reflexive without accent marks and dynamic contrasts or polyphonic elaborations however the homophonic weaving of the voices comes closer to serenity than the poem suggests

events archive vocalessence - Mar 31 2022

web may 12 2023 oct 26 2 30 pm 4 00 pm plymouth congregational church 1919 lasalle avenue minneapolis mn 55403 united states vocalessence is beginning its 55th season founder and artistic director philip brunelle will present a look at the october 29 opening concert vocalessence and the st olaf choir with guest composer jocelyn

[vocalessence wikipedia](#) - Sep 05 2022

web vocalessence has commissioned over 130 new works ranging from brief a cappella pieces to full scale choral and symphonic works vocalessence has co commissioned operas with opera theatre of st louis loss of eden by cary john franklin and the library of congress barnum s bird by libby larsen

[works vocalessence music press pdf pdf voto uncal edu](#) - Aug 04 2022

web works vocalessence music press pdf enjoying the song of phrase an emotional symphony within works vocalessence music press pdf in a global eaten by displays and the ceaseless chatter of quick conversation the melodic splendor and emotional symphony produced by the prepared term often fade in to the backdrop eclipsed by the relentless

vocalessence youtube - May 01 2022

web artistic director philip brunelle founded the internationally acclaimed choral music ensemble vocalessence in 1969 connect with mn original website

vocalessence remix vocalessence - Jan 09 2023

web a performance by vocalessence singers access to an audience who may want to perform your music possible publication through vocalessence music press apply complete the online application applications for the 2018 2019 vocalessence remix program are closed more information

vocalessence music press graphite publishing - Jul 15 2023

web vocalessence music press is a dynamic music publishing company that offers a select group of emerging composers the opportunity to make their music available to choirs everywhere and we offer choruses access to new music they can t find anywhere else

[works vocalessence music press pdf free blog watchshopping](#) - Feb 27 2022

web works vocalessence music press pdf introduction works vocalessence music press pdf free

kerala nmms result 2023 how to check at - Mar 31 2023

web kerala nmms result 2023 or kerala class 8th scholarship result 2023 has been declared by the government of kerala on

its nmms exam official website nmmse kerala gov in students who appeared the kerala nmmse or kerala national means cum merit scholarship examination can check details and download the result from the web page

nmms result 2023 state wise nmms result sarkarischools in - Nov 26 2022

web jun 19 2023 state examination board gandhinagar seb gujarat has released the nmms result 2023 for examination on 12 02 2023 candidates who want to check the nmms result 223 gujarat merit list is available sebexam org

nmms result 2023 scholarships gov in check state wise nmms exam - Dec 28 2022

web mar 18 2023 nmms result 2023 scholarships gov in the nmms result for 2023 will be made public online on the official websites of the relevant scerts the nmms 8th class result for 2023 is made public in some jurisdictions the nmms 2023 result is made available in the form of a merit list whereas in other states a login window is available to

nmms result 2023 24 check state wise nmms class 8th results - May 01 2023

web oct 20 2023 nmms result 2023 24 8th class haryana scert haryana will release the nmms result 2023 24 in online mode haryana nmms exam result is published on the official website secrtharyana gov in nmms 2023 24 result haryana is released as a merit list in pdf format

nmms - Jul 23 2022

web national means cum merit scholarship examination government of kerala notifications notifications nmmse 2023 registration extended circular 03 november 2023 nmmse 2023 notification 17 october 2023 best viewed in mozilla firefox 68 higher versions content designed developed by pareeksha bhavan

nmms result 2022 kerala class 8th scholarship result for - Mar 19 2022

web may 9 2022 candidates can check their nmms results online on the official website nmmse kerala gov in kerala nmms result 2021 22 has been declared for the exam held on march 22 2022 the kerala class 8th scholarship exam will help eligible students get a scholarship of rs 500 p m

[nmms result 2023 check state wise scholarship results](#) - Feb 15 2022

web jun 6 2023 directorate of government examinations has now declared the andhra pradesh nmms results on the portal a total of 158 candidates have been selected for the scholarship check the official website below to check the results

nmms selected list nov 2013 nmms exams results - Oct 06 2023



















web nmms selected list national merit cum means scholarship selected candidates list results for nmms examination nov 2013 the community wise district wise selected list of candidates for award of nmms scholarships for nmms examination held on november 2013 are released

nmms 2014 exam results no 1 educational site in tamilnadu - Jun 02 2023

web the question paper of nmms contained sat and mat questions in the objective form mental ability test questions were

asked from maths and scholastic aptitude test questions were asked from other subjects each question carried one mark and there was no negative mark for incorrect answer download link nmms 2014 exam results pdf

nmms exam result 2015 nmms scholarship result 2015 - Oct 26 2022

web mar 29 2016 nmms exam result 2015 nmms 2015 16                  

nmms result 2022 scholarship merit list selection - Jan 29 2023

web frequently asked questions q1 what is the qualifying mark for nmms 2022 answer the qualification score for passing the nmms exam is 40 for each of the mat and sat exams q2 when nmms results were out answer results for nmms202122 results for nmms manipur 2022 will be announced on may 25 2022 recently kerala we read full





































nmms application form 2023 24 nmm scholarship check now - May 21 2022

web aug 26 2023 short information the nmms application form uttar pradesh 2023 is an annual entrance exam held by authorities to identify eligible class 8 students from economically disadvantaged backgrounds its aim is to grant scholarships and encourage these students to pursue higher education addressing the issue of students

nmms exam result in 2013 willistowerswatson lifesight - Jun 21 2022

web nmms exam result in 2013 book review unveiling the magic of language in a digital era where connections and knowledge reign supreme the enchanting power of language has become more apparent than ever

nmms - Jul 03 2023

web                                     

nts nmms examination 2021 22 scert odisha - Apr 19 2022

web nmms examination 2023 24 national talent search examination ntse is a scheme of national council of educational research and traning it is a scheme which aims to provide wider platforms to the talented children by motivating them to develop themselves and to nurture them the examination nationaltalent search examination is two tier

nmms exam result 2021 scholarship help notification - Aug 24 2022

web jun 24 2021 nmms 2020 test is led for 180 imprints which incorporate two papers mental ability test mat and scholastic ability test sat nmms 2020 answer keys are delivered for the mat and sats not long after the test is the nmms test on the web students of class 8 can apply for the nmms test through on the web and disconnected

national means cum merit scholarship scheme ministry of - Sep 24 2022

web the test is conducted at stage of class viii the students who fulfill the eligibility criteria must pass both the tests i e mental ability test mat and scholastic aptitude test sat under nmms exam with at least 40 marks in aggregate taken together for these two tests for the sc st students this cut off is 32 marks

nmmse kerala - Sep 05 2023

web government of kerala messages nmmss examination 2023 application date has been extended upto 5 pm on 08 11 2023 last date for hm verification is 5 pm on 10 11 2023 nmmss examination 2023 please check the notifications menu for more details national means cum merit scholarship examination

nmms results check state wise nmms 2023 scholarship results - Aug 04 2023

web oct 19 2023 hummingbird olympiad nmms result 2023 once the nmms entrance exam has taken place the official authority announces the nmms exam result on the official website applicants can download the nmms result using the login credentials roll number and date of birth on the official website

kseab school activity karnataka - Feb 27 2023

web nmms examination helpline number 08023341615 login u dise code userid password enter captcha as shown below

preface to djamila boupacha political writings illinois - Feb 15 2023

web preface to djamila boupacha get access simone de beauvoir doi org 10 5406 illinois 9780252036941 003 0013 pages 272 282 published july 2012 cite permissions share extract

simone de beauvoir stanford encyclopedia of philosophy - Jul 20 2023

web aug 17 2004 in 1962 beauvoir and gisile halimi co authored the story of djamila boupacha an algerian girl accused of being a terrorist who was tortured by the french during the french algerian war this book may be read as an extension of beauvoir s critique of the marquis de sade

djamila boupacha beauvoir simone de 1908 free - Apr 05 2022

web 1962 topics boupacha djamila algeria history 1945 publisher paris gallimard collection inlibrary printdisabled internetarchivebooks contributor internet archive

djamila boupacha l interview youtube - May 06 2022

web apr 21 2022 0 00 8 32 djamila boupacha l interview france inter 1 04m subscribers subscribe france inter is a french public broadcast service wikipedia 80k views 1 year ago il y a 60 ans le 21

ethics and violence simone de beauvoir djamila boupacha - May 18 2023

web the title of beauvoir s article for djamila boupacha alluded to repeti tion in miming the title of jacques vergés and georges arnaud s 1957 mani festo for djamila bouhired beauvoir signaled both the urgency of intellectual engagement and her frustration at its failure in order to under

djamila boupacha wikiwand - Mar 16 2023

web djamila boupacha is a former militant from the algerian national liberation front she was arrested in 1960 for attempting to bomb a cafe in algiers 1 her confession which was obtained by means of torture and rape and her subsequent trial affected

french public opinion about the methods used by the french army in algeria after publicity by [djamila boupacha by simone de beauvoir open library](#) - Aug 09 2022

web dec 13 2022 djamila boupacha by simone de beauvoir 0 ratings 1 want to read 0 currently reading 0 have read this edition doesn't have a description yet can you add one publish date 1963 publisher four square books language french pages 255 previews available in french english subjects history djamila boupacha people

ethics and violence simone de beauvoir djamila boupacha - Sep 10 2022

web aug 15 2010 this article situates simone de beauvoir's involvement in the case of djamila boupacha an fln militant who was tortured by the french army in 1960 in the context of the repeated revelations of

[project muse from sensation to representation the torture of djamila](#) - Apr 17 2023

web abstract djamila boupacha was a militant member of the front de libération nationale fln who was accused of placing a bomb in the brasserie des facultés during the algerian war of independence 1954 1962

djamila boupacha wikipédia - Sep 22 2023

web djamila boupacha née le 9 février 1938 à bologhine anciennement saint eugène est une militante du front de libération nationale algérien fln arrêtée en 1960 pour une tentative d'attentat à alger

[boupacha djamila 1942 encyclopedia com](#) - Aug 21 2023

web boupacha djamila 1942 algerian nationalist heroine who was arrested as a terrorist in 1961 name variations djamilah born in algeria in 1942 married born into a middle class muslim family in 1942 djamila boupacha was more

[testimonial texts of torture during the algerian war paratexts](#) - Oct 11 2022

web may 5 2018 two testimonial texts written during the war henri alleg's la question 1958 and simone de beauvoir and gisèle halimi's djamila boupacha 1962 stand out as examples of writing about torture due to the texts' connections to the parisian intellectual community and their social political and literary repercussions

[we must shout the truth to the rooftops gisèle halimi djamila](#) - Jan 14 2023

web de beauvoir and halimi djamila boupacha 65 colloquium for history majors world france and algeria at war 16w 051 instructor dr mériam belli spring 2013 the university of iowa accounts of french sexual torture in the algerian war it is significant as a case study for discursive analysis

in defense of djamila boupacha simone de beauvoir - Dec 13 2022

web le monde 3 june 1960 appendix b in djamila boupacha the story of the torture of a young algerian girl which shocked liberal french opinion introduction to djamila boupacha edited by simone de beauvoir and gisèle halimi translated by peter green new york the macmillan company 1962

djamila boupacha the story of the torture of a young algerian girl - Jun 19 2023

web djamila boupacha the story of the torture of a young algerian girl which shocked liberal french opinion by beauvoir simone de 1908 publication date 1962 topics boupacha djamila algeria history 1945 1962 publisher new york macmillan

affaire djamila boupacha le tournant d une vie libération - Mar 04 2022

web jul 28 2020 affaire djamila boupacha le tournant d une vie article réservé aux abonnés gisèle halimi a défendu en 1960 la jeune femme militante du fln algérien arrêtée pour tentative d attentat puis

the case of djamila boupacha and an ethics of ambiguity - Nov 12 2022

web feb 10 2023 the case of djamila boupacha and an ethics of ambiguity opacity marronage and the veil ruthanne crapo kim the clr james journal philosophy documentation center the clr james journal online first published on february 10 2023 ruthanne crapo kim doi org 10 5840 clrjames202329103

djamila boupacha february 9 1938 june 28 1961 world - Jul 08 2022

web djamila boupacha february 9 1938 june 28 1961 world biographical encyclopedia djamila boupacha edit profile djamila boupacha is a former militant from the algerian national liberation front background djamila boupacha was born on 9 february 1938 in bologhine a suburb of algiers career

djamila boupacha the story of the torture of a young algerian girl - Jun 07 2022

web djamila boupacha the story of the torture of a young algerian girl which shocked liberal french opinion worldcat org authors simone de beauvoir gise le halimi print book english 1962 edition 1st american ed view all formats and editions publisher macmillan new york 1962 show more information location not available

djamila boupacha wikipedia - Oct 23 2023

web djamila boupacha born 9 february 1938 is a former militant from the algerian national liberation front she was arrested in 1960 for attempting to bomb a cafe in algiers