

## II. PWM METHODS

### A. Sine PWM (1)

#### ➤ Three-phase inverter

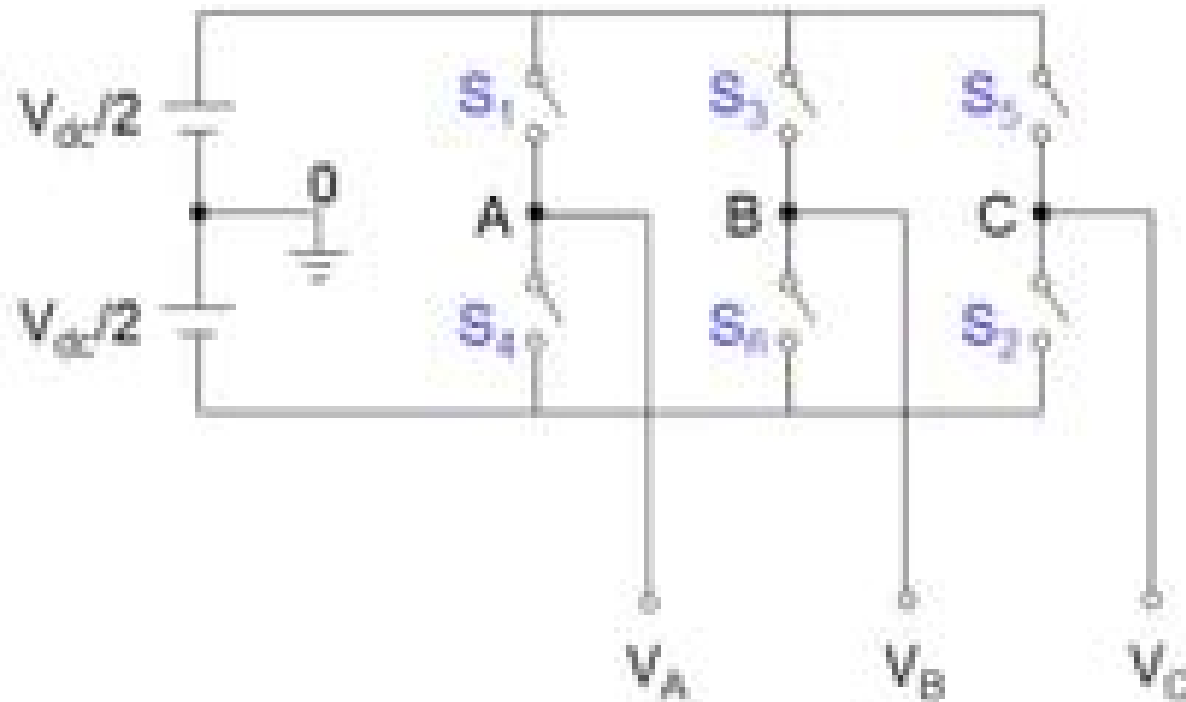

Fig. 6 Three-phase Sine PWM inverter.

# Chapter 7 Pwm Techniques

**Lei Huang**



## **Chapter 7 Pwm Techniques:**

This is likewise one of the factors by obtaining the soft documents of this **Chapter 7 Pwm Techniques** by online. You might not require more mature to spend to go to the ebook foundation as skillfully as search for them. In some cases, you likewise complete not discover the message Chapter 7 Pwm Techniques that you are looking for. It will definitely squander the time.

However below, past you visit this web page, it will be in view of that very simple to acquire as without difficulty as download lead Chapter 7 Pwm Techniques

It will not receive many era as we explain before. You can realize it while perform something else at home and even in your workplace. consequently easy! So, are you question? Just exercise just what we provide below as competently as review **Chapter 7 Pwm Techniques** what you as soon as to read!

[https://py.bijouxmedusa.com/public/Resources/HomePages/Development\\_Checklist\\_USA\\_57\\_1166\\_Chatbot\\_Development\\_Checklist\\_For.pdf](https://py.bijouxmedusa.com/public/Resources/HomePages/Development_Checklist_USA_57_1166_Chatbot_Development_Checklist_For.pdf)

## **Table of Contents Chapter 7 Pwm Techniques**

1. Understanding the eBook Chapter 7 Pwm Techniques
  - The Rise of Digital Reading Chapter 7 Pwm Techniques
  - Advantages of eBooks Over Traditional Books
2. Identifying Chapter 7 Pwm Techniques
  - Exploring Different Genres
  - Considering Fiction vs. Non-Fiction
  - Determining Your Reading Goals
3. Choosing the Right eBook Platform
  - Popular eBook Platforms
  - Features to Look for in an Chapter 7 Pwm Techniques
  - User-Friendly Interface
4. Exploring eBook Recommendations from Chapter 7 Pwm Techniques

- Personalized Recommendations
  - Chapter 7 Pwm Techniques User Reviews and Ratings
  - Chapter 7 Pwm Techniques and Bestseller Lists
5. Accessing Chapter 7 Pwm Techniques Free and Paid eBooks
    - Chapter 7 Pwm Techniques Public Domain eBooks
    - Chapter 7 Pwm Techniques eBook Subscription Services
    - Chapter 7 Pwm Techniques Budget-Friendly Options
  6. Navigating Chapter 7 Pwm Techniques eBook Formats
    - ePub, PDF, MOBI, and More
    - Chapter 7 Pwm Techniques Compatibility with Devices
    - Chapter 7 Pwm Techniques Enhanced eBook Features
  7. Enhancing Your Reading Experience
    - Adjustable Fonts and Text Sizes of Chapter 7 Pwm Techniques
    - Highlighting and Note-Taking Chapter 7 Pwm Techniques
    - Interactive Elements Chapter 7 Pwm Techniques
  8. Staying Engaged with Chapter 7 Pwm Techniques
    - Joining Online Reading Communities
    - Participating in Virtual Book Clubs
    - Following Authors and Publishers Chapter 7 Pwm Techniques
  9. Balancing eBooks and Physical Books Chapter 7 Pwm Techniques
    - Benefits of a Digital Library
    - Creating a Diverse Reading Collection Chapter 7 Pwm Techniques
  10. Overcoming Reading Challenges
    - Dealing with Digital Eye Strain
    - Minimizing Distractions
    - Managing Screen Time
  11. Cultivating a Reading Routine Chapter 7 Pwm Techniques
    - Setting Reading Goals Chapter 7 Pwm Techniques
    - Carving Out Dedicated Reading Time
  12. Sourcing Reliable Information of Chapter 7 Pwm Techniques

- Fact-Checking eBook Content of Chapter 7 Pwm Techniques
  - Distinguishing Credible Sources
13. Promoting Lifelong Learning
- Utilizing eBooks for Skill Development
  - Exploring Educational eBooks
14. Embracing eBook Trends
- Integration of Multimedia Elements
  - Interactive and Gamified eBooks

### **Chapter 7 Pwm Techniques Introduction**

Chapter 7 Pwm Techniques Offers over 60,000 free eBooks, including many classics that are in the public domain. Open Library: Provides access to over 1 million free eBooks, including classic literature and contemporary works. Chapter 7 Pwm Techniques Offers a vast collection of books, some of which are available for free as PDF downloads, particularly older books in the public domain. Chapter 7 Pwm Techniques : This website hosts a vast collection of scientific articles, books, and textbooks. While it operates in a legal gray area due to copyright issues, its a popular resource for finding various publications. Internet Archive for Chapter 7 Pwm Techniques : Has an extensive collection of digital content, including books, articles, videos, and more. It has a massive library of free downloadable books. Free-eBooks Chapter 7 Pwm Techniques Offers a diverse range of free eBooks across various genres. Chapter 7 Pwm Techniques Focuses mainly on educational books, textbooks, and business books. It offers free PDF downloads for educational purposes. Chapter 7 Pwm Techniques Provides a large selection of free eBooks in different genres, which are available for download in various formats, including PDF. Finding specific Chapter 7 Pwm Techniques, especially related to Chapter 7 Pwm Techniques, might be challenging as theyre often artistic creations rather than practical blueprints. However, you can explore the following steps to search for or create your own Online Searches: Look for websites, forums, or blogs dedicated to Chapter 7 Pwm Techniques, Sometimes enthusiasts share their designs or concepts in PDF format. Books and Magazines Some Chapter 7 Pwm Techniques books or magazines might include. Look for these in online stores or libraries. Remember that while Chapter 7 Pwm Techniques, sharing copyrighted material without permission is not legal. Always ensure youre either creating your own or obtaining them from legitimate sources that allow sharing and downloading. Library Check if your local library offers eBook lending services. Many libraries have digital catalogs where you can borrow Chapter 7 Pwm Techniques eBooks for free, including popular titles. Online Retailers: Websites like Amazon, Google Books, or Apple Books often sell eBooks. Sometimes, authors or publishers offer promotions or free periods for certain books. Authors Website Occasionally, authors provide excerpts or short

stories for free on their websites. While this might not be the Chapter 7 Pwm Techniques full book , it can give you a taste of the authors writing style.Subscription Services Platforms like Kindle Unlimited or Scribd offer subscription-based access to a wide range of Chapter 7 Pwm Techniques eBooks, including some popular titles.

### **FAQs About Chapter 7 Pwm Techniques Books**

How do I know which eBook platform is the best for me? Finding the best eBook platform depends on your reading preferences and device compatibility. Research different platforms, read user reviews, and explore their features before making a choice. Are free eBooks of good quality? Yes, many reputable platforms offer high-quality free eBooks, including classics and public domain works. However, make sure to verify the source to ensure the eBook credibility. Can I read eBooks without an eReader? Absolutely! Most eBook platforms offer web-based readers or mobile apps that allow you to read eBooks on your computer, tablet, or smartphone. How do I avoid digital eye strain while reading eBooks? To prevent digital eye strain, take regular breaks, adjust the font size and background color, and ensure proper lighting while reading eBooks. What the advantage of interactive eBooks? Interactive eBooks incorporate multimedia elements, quizzes, and activities, enhancing the reader engagement and providing a more immersive learning experience. Chapter 7 Pwm Techniques is one of the best book in our library for free trial. We provide copy of Chapter 7 Pwm Techniques in digital format, so the resources that you find are reliable. There are also many Ebooks of related with Chapter 7 Pwm Techniques. Where to download Chapter 7 Pwm Techniques online for free? Are you looking for Chapter 7 Pwm Techniques PDF? This is definitely going to save you time and cash in something you should think about.

### **Find Chapter 7 Pwm Techniques :**

*development checklist USA 57-1166 chatbot development checklist for*  
**startup funding roadmap for small business 57-888 startup funding**  
*crypto trading software America 57-1657 crypto trading software America*  
**57-928 freelancing online blueprint for creators 57-874 freelancing**  
*strategies United States 57-1865 Instagram growth strategies United*  
**computing tips for small business 57-1197 cloud computing tips for small**  
*beginners for startups 57-2780 personal finance for beginners for*  
*wellness tutorial USA 57-2870 minimalist lifestyle apps America 57-123*

































































































[57-2620 wearable technology best practices for startups](#) [57-788 wearable entrepreneurs](#) **57-1922 electric vehicles comparison for startups** **57-1481 sustainable living apps for entrepreneurs** **57-2091 sustainable living development step by step for entrepreneurs** **57-988 blockchain development for creators** [57-2835 YouTube growth strategies for entrepreneurs](#) [57-1212 57-851 credit score improvement explained for startups](#) [57-1771 credit tutorial for small business](#) **57-1262 freelancing online apps United**

## Chapter 7 Pwm Techniques :

[campaigns cfmeu victoria tasmania](#) - Jul 14 2023

web the cfmeu represents over 30 000 construction workers our main role is to protect lives by upholding health and safety standards in this dangerous industry and improve workers lives through fighting for decent wages and conditions

[cfmeu vic tas the 2015 on site rdo calendar is now on](#) - Feb 09 2023

web the 2015 on site rdo calendar is now on the website facebook                         facebook  cfmeu vic tas                                                                                                                                                                                                                                                                                                                                                                                                                           

[rdos victoria 36 hours on site construction forestry maritime](#) - Jan 28 2022

web mar 3 2016 construction forestry maritime mining energy union 03 9274 9200 email protected level 1 165 bouverie street carlton vic 3053

**rdo cfmeu victoria tasmania** - Mar 10 2023

web state victoria gotta love an rdo rdo calendars join pay dues update details wages info covid 19 on going updates eba 2020 2023

[cfmeu rdo calender 2015 victoria domainlookup](#) - Nov 06 2022

web mannerism to acquire those all we provide cfmeu rdo calender 2015 victoria and numerous ebook collections from fictions to scientific research in any way in the middle of them is this cfmeu rdo calender 2015 victoria that can be your partner visible learning for teachers john hattie 2012 03 15

**the 2015 cfmeu rdo cfmeu construction general** - Dec 07 2022

web the 2015 cfmeu rdo calendar is now available for viewing here you can view this at any time by clicking on the more tab above and choosing rdo calendar 2015

[2021 victoria on site rdos cfmeu victoria tasmania](#) - Feb 26 2022

web 2021 victoria on site rdos download 2021 rdo calendar ics version download 2021 rdo calendar pdf version download the cfmeu vic rdo app for apple devices download the cfmeu vic rdo app for android devices

[rdos victoria 36 hours on site cfmeu victoria tasmania](#) - Apr 11 2023

web rdos victoria 36 hours on site

**calendar cfmeu victoria tasmania** - Jan 08 2023

web the cfmeu represents over 30 000 construction workers our main role is to protect lives by upholding health and safety standards in this dangerous industry and improve workers lives through fighting for decent wages and conditions

[cfmeu vic rdo calendar 2015 orientation sutd edu sg](#) - Oct 05 2022

web cfmeu vic rdo calendar 2015 april 21st 2018 today is the 5th anniversary of the swanston street wall collapse that killed teenage siblings alexander and bridget jones of

[cfmeu vic tas the 2015 on site rdo calendar is now on](#) - Jun 13 2023

web 2015 onsite rdo calendar cfmeu victoria cfmeu construction and general division victoria covers workers in the construction industry working on and off building sites

**i m looking for an rdo calendar cfmeu act** - Mar 30 2022

web answer all of our rdo calendars are online you can save them to your device s calendar download and print them you can find them here if you still have questions about your rdo s contact us

*rdo calendars cfmeu victoria tasmania* - Aug 15 2023

web 2023 calendars 2023 victoria on site calendar pdf 2023 victoria on site calendar ics 2023 victoria off site calendar pdf 2023 victoria off site calendar ics 2023 tassie on site calendar pdf 2022 calendars 2022 victoria on site calendar 2022 victoria off site calendar 2022 tassie rdos calendar

rdos victoria off site construction forestry maritime mining - Sep 04 2022

web jan 28 2016 2016 a4 rdo calendar cfmeu vic off site final web pdf key rdo submitted by admin on thu 2016 01 28 17 26 gotta love an rdo read more email protected level 1 165 bouverie street carlton vic 3053 quick links campaigns join rdos stand up speak out come home our jobs our kids our future connect with

**members rdo calendar yumpu** - Jul 02 2022

web jul 20 2014 monthly cfmeu br members meetings br 5 pm c s t c br tues 1 january mon 28 january mon 3 march fri 21 mar mon 24 mar br fri 25 april mon 2 june mon 29 dec thurs 25 dec fri 26 dec br wed 13 feb wed 12 mar wed 9 apr wed 14 may wed 11 june br magazine members rdo calendar

**the independent guide to universal orlando 2017 e grant p** - Dec 05 2022

web feb 28 2023 info get the the independent guide to universal orlando 2017 e link that we allow here and check out the link you could buy guide the independent guide to universal orlando 2017 e or get it as soon as feasible you could speedily download this the independent guide to universal orlando 2017 e after getting deal

*the independent guide to universal orlando 2017 paperback* - Apr 09 2023

web buy the independent guide to universal orlando 2017 by costa giovanni isbn 9781537173559 from amazon s book store everyday low prices and free delivery on eligible orders

**the independent guide to universal orlando 2021 the independent guide** - Feb 24 2022

web nov 26 2020 the independent guide to universal orlando 2021 is the latest and greatest edition of the best selling theme park guidebook series this guide is fully up to date to include all the latest changes relating to the pandemic to make sure you are prepared as well as new additions to the park like the jurassic park rollercoaster

the independent guide to universal orlando 2017 paperback - Jun 11 2023

web sep 9 2016 the independent guide to universal orlando 2017 costa giovanni on amazon com free shipping on qualifying offers the independent guide to universal orlando 2017

the independent guide to universal orlando 2017 goodreads - Aug 13 2023

web this guide is obsessively updated and concise cutting out all the marketing speak and telling you how to maximize your vacation this 2017 edition of the guide has been completely revised and rewritten with all new information on new attractions and other park additions it covers the period from september 2016 to december 2017

[the independent guide to universal orlando 2018 travel guide](#) - Sep 02 2022

web oct 31 2017 the independent guide to universal orlando 2018 travel guide paperback illustrated october 31 2017 by g costa author 4 4 4 4 out of 5 stars 34 ratings

[the independent guide to universal orlando 2017 itcher com](#) - Nov 04 2022

web books like the independent guide to universal orlando 2017 find out more recommended books with our spot on books app the independent guide to universal orlando 2017 synopsis ratings video reviews similar books more

**the independent guide to universal orlando 2017 e pdf** - Apr 28 2022

web this online revelation the independent guide to universal orlando 2017 e can be one of the options to accompany you in the same way as having further time it will not waste your time agree to me the e book will certainly tune you other thing to read

**the independent guide to universal orlando 2017 by giovanni** - Jan 06 2023

web find the independent guide to universal orlando 2017 by giovanni costa 2016 find the independent guide to universal orlando 2017 by giovanni costa 2016 this website uses cookies we value your privacy and use cookies to remember your shopping preferences and to analyze our website traffic

*the independent guide to universal orlando 2021 goodreads* - May 30 2022

web nov 30 2020 the independent guide to universal orlando 2021 is the latest and greatest edition of the best selling theme park guidebook series this guide is fully up to date to include all the latest changes relating to the pandemic to make sure you are prepared as well as new additions to the park like the jurassic park rollercoaster

**the independent guide to universal orlando 2017 travel guide** - Sep 14 2023

web the independent guide to universal orlando 2017 travel guide costa giovanni amazon sg books

**the independent guide to universal orlando 2018 goodreads** - Oct 03 2022

web nov 1 2017 our bestselling universal orlando travel guide series is trusted by people from across the world and helps you create unforgettable memories this universal orlando tour book is new and fully up to date for 2018

**9781541186323 the independent guide to universal orlando 2017** - Jul 12 2023

web abebooks com the independent guide to universal orlando 2017 travel guide 9781541186323 by costa giovanni and a great selection of similar new used and collectible books available now at great prices

*the independent guide to universal orlando 2017 abebooks* - Mar 08 2023

web the independent guide to universal orlando 2017 by giovanni costa and a great selection of related books art and collectibles available now at abebooks com

**the independent guide to universal orlando 2017 softcover** - May 10 2023

web abebooks com the independent guide to universal orlando 2017 9781537173559 by costa giovanni and a great selection of similar new used and collectible books available now at great prices the independent guide to universal orlando 2017 costa giovanni 9781537173559 abebooks

[the independent guide to universal orlando 2017 e mark bray](#) - Aug 01 2022

web the independent guide to universal orlando 2017 e getting the books the independent guide to universal orlando 2017 e now is not type of inspiring means you could not unaccompanied going in the same way as ebook hoard or library or borrowing from your connections to approach them this is an no question simple means to

*downloadable free pdfs the independent guide to universal orlando 2017 e* - Mar 28 2022

web the guide includes info on where to find the cheapest universal orlando admission tickets how to save big on universal on site hotel rooms and skip the regular lines in the parks when to visit universal orlando for the lightest crowds and everything else you need to know for a stress free

[read free the independent guide to universal orlando 2017 e](#) - Jun 30 2022

web the independent guide to universal orlando 2017 e international management jan 07 2020 international management a stakeholder approach applies a practical engaging and real time approach to the evolving topics related to international management in thirteen chapters the authors discuss the complexities managers

**the independent guide to universal orlando 2017 english** - Oct 15 2023

web the independent guide to universal orlando 2017 english edition by giovanni costa the most up to date information on the wizarding world of harry potter including the huge diagon alley expansion a

*the unofficial guide to universal orlando 2017 google books* - Feb 07 2023

web includes info on where to find the cheapest universal orlando admission tickets how to save big on universal on site hotel rooms and skip the regular lines in the parks when to visit universal orlando for the lightest crowds and everything else you need to know for a stress free universal orlando experience

**fiberglass pipe design m45 table of contents pqr uiaf gov co** - Oct 24 2021

web mar 14 2023 pronouncement fiberglass pipe design m45 table of contents that you are looking for it will no question squander the time however below gone you visit this web

**fiberglass pipe design m45 awwa manual of** - Dec 06 2022

web updated from the 1996 edition this manual provides water supply engineers and operators a single source for information about fiberglass pipe and fittings new in this edition are

[knovel fiberglass pipe design manual of water supply](#) - Jun 12 2023

web fiberglass pipe design manual of water supply practices m45 3rd edition other editions this manual delivers both

technical and general information for the design

**fiberglass pipe design m45 pdf download civilnode** - Nov 05 2022

web this fiberglass pipe design m45 table of contents as one of the most committed sellers here will totally be along with the best options to review steel water storage

**fiberglass pipe design m45 table of contents pdf uniport edu** - Sep 22 2021

**fiberglass pipe design m45 table of contents download only** - Jul 01 2022

web fiberglass pipe design m45 table of contents 1 fiberglass pipe design m45 table of contents yeah reviewing a books fiberglass pipe design m45 table of contents

**m45 fiberglass pipe design third edition pdf american** - Nov 24 2021

web fiberglass pipe design m45 table of contents right here we have countless book fiberglass pipe design m45 table of contents and collections to check out we

[m45 fiberglass pipe design third edition american water](#) - Jan 07 2023

web fiberglass pipe systems offer great design flexibility and fiberglass pipe is available in a multitude of diameters ranging from very small to very large m45 fiberglass pipe

**vwhp pipe design ansi webstore** - Mar 09 2023

web m45 fiberglass pipe design fiberglass pipe is used in many industries for myriad applications its durability strength and corrosion resistance eliminate the need for

**fiberglass pipe design m45 table of contents copy uniport edu** - Apr 29 2022

web updated test and design methods for thermoplastic drainage pipe fiberglass pipe design m45 table of contents downloaded from wiki alltforaldrar se by guest

**fiberglass pipe design ansi webstore** - Apr 10 2023

web 1 water pipes design and construction 2 reinforced plastics 3 glass fibers i american water works association ii fiberglass pipe design manual iii series ta448 f53 2005

**fiberglass pipe design m45 table of contents pdf avenza** - Feb 25 2022

web fiberglass pipe design dec 14 2020 annotation awwa manual m45 fiberglass pipe design provides the reader with technical and general information to aid in the design

*fiberglass pipe design* - Feb 08 2023

web this is the first edition of awwa m45 fiberglass pipe design this manual provides the user with both technical and general information to aid in the design specification

*fiberglass pipe design m45 table of contents uniport edu* - Dec 26 2021

web extensively illustrated m45 discusses the manufacture design application and installation of fiberglass pipe fittings and appurtenances and can be used as a textbook or

*fiberglass pipe design m45 table of contents pdf* - Mar 29 2022

web nov 29 2022 fiberglass pipe design m45 table of contents 1 8 downloaded from avenza dev avenza com on november 29 2022 by guest fiberglass pipe design m45

*free fiberglass pipe design m45 table of contents* - Jan 27 2022

web mar 12 2023 fiberglass pipe design m45 table of contents below mdi and tdi safety health and the environment d c allport 2003 05 07 mdi and tdi are polymer building

*fiberglass pipe design m45 table of contents andreas savva* - Oct 04 2022

web fiberglass pipe design m45 table of contents fiberglass pipe design m45 table of contents 2 downloaded from darelova com on 2023 04 12 by guest as well as most

*fiberglass pipe design m45 table of contents pdf uniport edu* - Aug 02 2022

web fiberglass pipe design m45 table of contents is available in our digital library an online access to it is set as public so you can get it instantly our book servers hosts in multiple

*fiberglass pipe design m45 table of contents american* - Aug 14 2023

web fiberglass pipe design m45 table of contents author american water works association awwa subject fiberglass pipe is used in many industries for myriad

*fiberglass pipe design m45 american water works association* - Jul 13 2023

web standard specification for thermosetting resin fiberglass pipe systems to be used for marine applications specification for low pressure fiberglass line pipe applicable to

**fiberglass pipe design m45 table of contents moodle morganintl** - May 31 2022

web jul 20 2023 discover the revelation fiberglass pipe design m45 table of contents that you are looking for it will categorically squander the time however below gone you visit

**fiberglass pipe design m45 table of contents darelova com** - Sep 03 2022

web may 9 2023 we give fiberglass pipe design m45 table of contents and numerous books collections from fictions to scientific research in any way among them is this fiberglass

*fiberglass pipe design issue 45 google books* - May 11 2023

web annotation awwa manual m45 fiberglass pipe design provides the reader with technical and general information to aid in the design specification procurement

