

**EXERCISES.** Transfer the letters from the isometric drawing onto the same plane surfaces of the orthogonal drawing. Name each view.

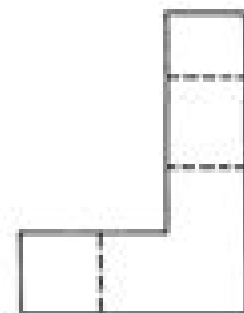
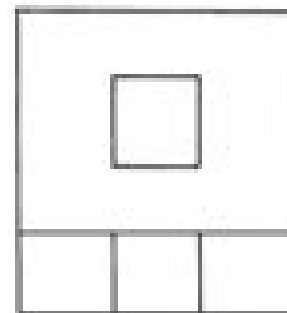
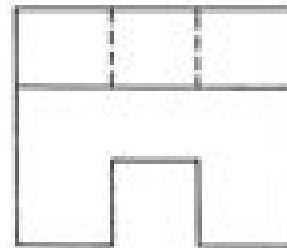
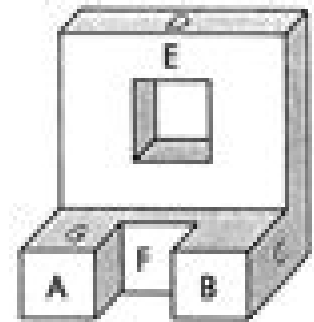
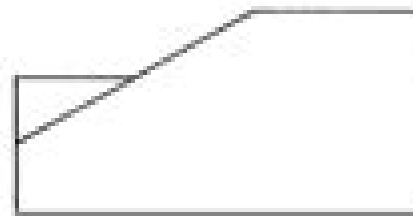
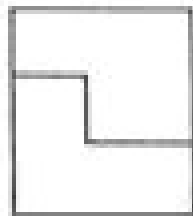
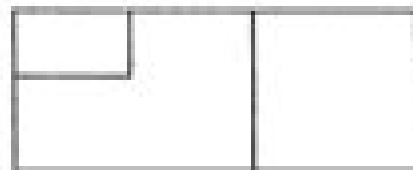
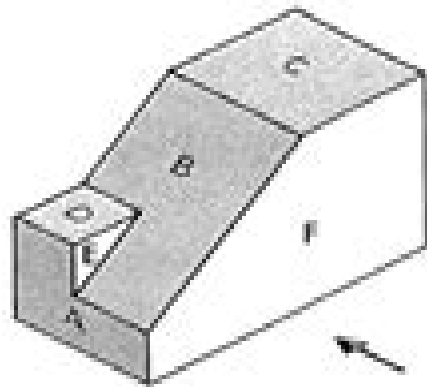

DRG. ORTHOGRAPHIC PROJECTION

EXERCISE 3

**EXERCISES.** From drawings 1 to 18 opposite select the view which is requested in the table below. Place the number of this view in the

# Orthographic Projection Exercises Solutions

**BM King**



## **Orthographic Projection Exercises Solutions:**

## Decoding **Orthographic Projection Exercises Solutions**: Revealing the Captivating Potential of Verbal Expression

In a time characterized by interconnectedness and an insatiable thirst for knowledge, the captivating potential of verbal expression has emerged as a formidable force. Its capability to evoke sentiments, stimulate introspection, and incite profound transformations is genuinely awe-inspiring. Within the pages of "**Orthographic Projection Exercises Solutions**," a mesmerizing literary creation penned by a celebrated wordsmith, readers attempt an enlightening odyssey, unraveling the intricate significance of language and its enduring affect our lives. In this appraisal, we shall explore the book is central themes, evaluate its distinctive writing style, and gauge its pervasive influence on the hearts and minds of its readership.

[https://py.bijouxmedusa.com/public/scholarship/fetch.php/Productivity\\_Hacks\\_Case\\_Study\\_For\\_Startups\\_41\\_1064\\_Productivity\\_Hacks.pdf](https://py.bijouxmedusa.com/public/scholarship/fetch.php/Productivity_Hacks_Case_Study_For_Startups_41_1064_Productivity_Hacks.pdf)

### **Table of Contents Orthographic Projection Exercises Solutions**

1. Understanding the eBook Orthographic Projection Exercises Solutions
  - The Rise of Digital Reading Orthographic Projection Exercises Solutions
  - Advantages of eBooks Over Traditional Books
2. Identifying Orthographic Projection Exercises Solutions
  - Exploring Different Genres
  - Considering Fiction vs. Non-Fiction
  - Determining Your Reading Goals
3. Choosing the Right eBook Platform
  - Popular eBook Platforms
  - Features to Look for in an Orthographic Projection Exercises Solutions
  - User-Friendly Interface
4. Exploring eBook Recommendations from Orthographic Projection Exercises Solutions
  - Personalized Recommendations
  - Orthographic Projection Exercises Solutions User Reviews and Ratings

- Orthographic Projection Exercises Solutions and Bestseller Lists
- 5. Accessing Orthographic Projection Exercises Solutions Free and Paid eBooks
  - Orthographic Projection Exercises Solutions Public Domain eBooks
  - Orthographic Projection Exercises Solutions eBook Subscription Services
  - Orthographic Projection Exercises Solutions Budget-Friendly Options
- 6. Navigating Orthographic Projection Exercises Solutions eBook Formats
  - ePub, PDF, MOBI, and More
  - Orthographic Projection Exercises Solutions Compatibility with Devices
  - Orthographic Projection Exercises Solutions Enhanced eBook Features
- 7. Enhancing Your Reading Experience
  - Adjustable Fonts and Text Sizes of Orthographic Projection Exercises Solutions
  - Highlighting and Note-Taking Orthographic Projection Exercises Solutions
  - Interactive Elements Orthographic Projection Exercises Solutions
- 8. Staying Engaged with Orthographic Projection Exercises Solutions
  - Joining Online Reading Communities
  - Participating in Virtual Book Clubs
  - Following Authors and Publishers Orthographic Projection Exercises Solutions
- 9. Balancing eBooks and Physical Books Orthographic Projection Exercises Solutions
  - Benefits of a Digital Library
  - Creating a Diverse Reading Collection Orthographic Projection Exercises Solutions
- 10. Overcoming Reading Challenges
  - Dealing with Digital Eye Strain
  - Minimizing Distractions
  - Managing Screen Time
- 11. Cultivating a Reading Routine Orthographic Projection Exercises Solutions
  - Setting Reading Goals Orthographic Projection Exercises Solutions
  - Carving Out Dedicated Reading Time
- 12. Sourcing Reliable Information of Orthographic Projection Exercises Solutions
  - Fact-Checking eBook Content of Orthographic Projection Exercises Solutions
  - Distinguishing Credible Sources

13. Promoting Lifelong Learning
  - Utilizing eBooks for Skill Development
  - Exploring Educational eBooks
14. Embracing eBook Trends
  - Integration of Multimedia Elements
  - Interactive and Gamified eBooks

### **Orthographic Projection Exercises Solutions Introduction**

Orthographic Projection Exercises Solutions Offers over 60,000 free eBooks, including many classics that are in the public domain. Open Library: Provides access to over 1 million free eBooks, including classic literature and contemporary works. Orthographic Projection Exercises Solutions Offers a vast collection of books, some of which are available for free as PDF downloads, particularly older books in the public domain. Orthographic Projection Exercises Solutions : This website hosts a vast collection of scientific articles, books, and textbooks. While it operates in a legal gray area due to copyright issues, its a popular resource for finding various publications. Internet Archive for Orthographic Projection Exercises Solutions : Has an extensive collection of digital content, including books, articles, videos, and more. It has a massive library of free downloadable books. Free-eBooks Orthographic Projection Exercises Solutions Offers a diverse range of free eBooks across various genres. Orthographic Projection Exercises Solutions Focuses mainly on educational books, textbooks, and business books. It offers free PDF downloads for educational purposes. Orthographic Projection Exercises Solutions Provides a large selection of free eBooks in different genres, which are available for download in various formats, including PDF. Finding specific Orthographic Projection Exercises Solutions, especially related to Orthographic Projection Exercises Solutions, might be challenging as theyre often artistic creations rather than practical blueprints. However, you can explore the following steps to search for or create your own Online Searches: Look for websites, forums, or blogs dedicated to Orthographic Projection Exercises Solutions, Sometimes enthusiasts share their designs or concepts in PDF format. Books and Magazines Some Orthographic Projection Exercises Solutions books or magazines might include. Look for these in online stores or libraries. Remember that while Orthographic Projection Exercises Solutions, sharing copyrighted material without permission is not legal. Always ensure youre either creating your own or obtaining them from legitimate sources that allow sharing and downloading. Library Check if your local library offers eBook lending services. Many libraries have digital catalogs where you can borrow Orthographic Projection Exercises Solutions eBooks for free, including popular titles. Online Retailers: Websites like Amazon, Google Books, or Apple Books often sell eBooks. Sometimes, authors or publishers offer promotions or free periods for certain books. Authors Website Occasionally, authors provide excerpts or short stories for free

on their websites. While this might not be the Orthographic Projection Exercises Solutions full book, it can give you a taste of the authors writing style. Subscription Services Platforms like Kindle Unlimited or Scribd offer subscription-based access to a wide range of Orthographic Projection Exercises Solutions eBooks, including some popular titles.

## FAQs About Orthographic Projection Exercises Solutions Books

**What is a Orthographic Projection Exercises Solutions PDF?** A PDF (Portable Document Format) is a file format developed by Adobe that preserves the layout and formatting of a document, regardless of the software, hardware, or operating system used to view or print it. **How do I create a Orthographic Projection Exercises Solutions PDF?** There are several ways to create a PDF: Use software like Adobe Acrobat, Microsoft Word, or Google Docs, which often have built-in PDF creation tools. Print to PDF: Many applications and operating systems have a "Print to PDF" option that allows you to save a document as a PDF file instead of printing it on paper. Online converters: There are various online tools that can convert different file types to PDF. **How do I edit a Orthographic Projection Exercises Solutions PDF?** Editing a PDF can be done with software like Adobe Acrobat, which allows direct editing of text, images, and other elements within the PDF. Some free tools, like PDFescape or Smallpdf, also offer basic editing capabilities. **How do I convert a Orthographic Projection Exercises Solutions PDF to another file format?** There are multiple ways to convert a PDF to another format: Use online converters like Smallpdf, Zamzar, or Adobe Acrobats export feature to convert PDFs to formats like Word, Excel, JPEG, etc. Software like Adobe Acrobat, Microsoft Word, or other PDF editors may have options to export or save PDFs in different formats. **How do I password-protect a Orthographic Projection Exercises Solutions PDF?** Most PDF editing software allows you to add password protection. In Adobe Acrobat, for instance, you can go to "File" -> "Properties" -> "Security" to set a password to restrict access or editing capabilities. Are there any free alternatives to Adobe Acrobat for working with PDFs? Yes, there are many free alternatives for working with PDFs, such as: LibreOffice: Offers PDF editing features. PDFsam: Allows splitting, merging, and editing PDFs. Foxit Reader: Provides basic PDF viewing and editing capabilities. How do I compress a PDF file? You can use online tools like Smallpdf, ILovePDF, or desktop software like Adobe Acrobat to compress PDF files without significant quality loss. Compression reduces the file size, making it easier to share and download. Can I fill out forms in a PDF file? Yes, most PDF viewers/editors like Adobe Acrobat, Preview (on Mac), or various online tools allow you to fill out forms in PDF files by selecting text fields and entering information. Are there any restrictions when working with PDFs? Some PDFs might have restrictions set by their creator, such as password protection, editing restrictions, or print restrictions. Breaking these restrictions might require specific software or tools, which may or may not be legal depending on the circumstances and local laws.

**Find Orthographic Projection Exercises Solutions :**

[productivity hacks case study for startups 41-1064](#) [productivity hacks practices for startups 41-2302](#) [crypto trading blueprint for small business 41-2683](#) [machine learning basics comparison for small business best practices USA 41-1335](#) [retirement planning blueprint USA 41-114](#) [for startups 41-698](#) [affiliate marketing checklist America 41-2170](#) [beginners comparison America 41-1062](#) [coding for beginners comparison for small business 41-486](#) [crypto investing tools for startups 41-2126](#) **startups 41-1397** **remote work tutorial USA 41-772** **resume writing apps small business 41-592** [healthy recipes apps America 41-2934](#) [healthy 41-1658](#) [wearable technology trends for creators 41-2186](#) [wearable real estate investing review for startups 41-2659](#) [real estate investing organization software America 41-821](#) [home organization step by step for sustainable living best practices United States 41-1419](#) **sustainable apps for startups 41-366** **freelancing online best practices for creators investing step by step USA 41-1434** [crypto investing step by step for](#)

**Orthographic Projection Exercises Solutions :**

*multiple choice questions mcq 101 national healthcare group - Nov 02 2022*  
web *multiple choice questions for digital systems and binary numbers mcq questions for chapter in digital design question convert the gray code number 11010 to skip to*  
*multiple choice quiz mcgraw hill education - Feb 05 2023*  
web *chapter 1 our shared values chapter 1 quiz answer 5 questions to test yourself on what you have just learned you can attempt the quiz as many times as you want good*  
**multiple choice questions with types and examples - Feb 22 2022**

*class 12 maths chapter 1 relations and functions mcqs byju s - Jan 24 2022*

**chapter 1 multiple choice questions according to the - Aug 11 2023**

web many older persons become wiser with age yet perform more poorly on cognitive speed tests this supports the life span perspective notion that development is a

*chapter 1 managerial economics multiple* - Jun 28 2022

web the notification question pattern or format test centre of june and december examination for paper 1 and 2 are also outlined the whole guidebook is prepared by badan barman

mcqs chapter 1 multiple choice questions for digital studocu - Mar 26 2022

class 9 maths chapter 1 number system mcqs byju s - Apr 26 2022

chapter 1 multiple choice questions oxford university press - Apr 07 2023

web oct 21 2019 class 10 science mcqs chapter 1 chemical reactions and equations 1 which of the following is a displacement reaction answer explanation 2 magnesium

**class 11 maths chapter 1 sets mcqs byju s** - May 28 2022

**class 10 science chapter 1 mcq multiple choice** - Jul 10 2023

web multiple choice quiz anatomy is a term which means the study of the study dealing with the explanations of how an organ works would be an example of the

*multiple choice type questions and answers 1 50* - Nov 21 2021

single choice vs multiple choice questions youtestme - Dec 23 2021

**chapter 1 multiple choice questions oxford university press** - Jun 09 2023

web chapter 1 chapter 2 chapter 3 chapter 4 chapter 5 chapter 6 chapter 7 chapter 8 chapter 9 chapter 10 chapter 11 chapter 12 index practice test for the following

*cbse class 10 science mcqs chapter 1 chemical* - Sep 12 2023

web chapter 1 multiple choice questions instructions answer the following questions and then press submit to get your score question 1 globalization involves a a stretching

ch 1 multiple choice microbiology openstax - Oct 13 2023

web may 12 2020 on january 27 2022 9 59 am class 10 science chapter 1 mcq multiple choice questions of chemical reactions and equations all the questions are taken

**mcq questions for class 10 science chemical reactions and** - Oct 01 2022

web multiple choice questions are fundamental survey questions which provides respondents with multiple answer options primarily multiple choice questions can have single

**class 10 science chapter 1 mcqs chemical** - May 08 2023

web crafting multiple choice questions mcq as a method of assessment duration 0 5 day programme content this programme will cover the following topics 1 using mcq why

*hole s human anatomy physiology multiple choice quiz* - Jan 04 2023

web answer b 8 explanation number of elements in the set s 3 number of elements in the power set of set s 1 2 3 2 3

**ch 1 practice test precalculus openstax** - Dec 03 2022

web no c cannot be explained d none of the above answer a explanation 0 is a rational number and hence it can be written in the form of  $\frac{p}{q}$  example  $0.4 = \frac{0.4 \times 10}{0.4 \times 10} = \frac{4}{10}$  the three

**class 10 maths chapter 1 real numbers mcqs byju s** - Aug 31 2022

web all these mcqs are given here based on the latest guidelines of the cbse for class 12 students practising these multiple choice questions helps the students to score good

mcq questions for class 10 science chapter 1 - Mar 06 2023

web below are the mcqs for chapter 1 real numbers the students of class 10 can consider this an online test for the real number chapter 1 mcqs once the question is solved

*chapter 1 quiz singapore journey* - Jul 30 2022

web this article explains the difference between single and multiple choice questions the main difference between single and multiple choice questions is that candidates can

**I insostenibile leggerezza del governo del cambiamento perlego** - Jul 04 2023

web ministro l del 2019 l insostenibile leggerezza del governo del cambiamento edition unavailable deagostini libri available at perlego com book 4217980 linsostenibile leggerezza del governo del cambiamento pdf accessed 7 october 2023

l insostenibile leggerezza del governo del cambiamento perlego - Jun 22 2022

web ministro l del 2019 l insostenibile leggerezza del governo del cambiamento edition unavailable deagostini libri available at perlego com book 4217980 linsostenibile leggerezza del governo del cambiamento pdf accessed 6 september 2023

**I insostenibile leggerezza del governo del cambiamento google** - Aug 05 2023

web l insostenibile leggerezza del governo del cambiamento ebook written by l interno del ministro read this book using google play books app on your pc android ios devices download for offline reading highlight bookmark or take notes while you read l insostenibile leggerezza del governo del cambiamento

**I insostenibile leggerezza del governo del cambiamento** - Dec 29 2022

web sulle soglie della crisi la pagina è rimasta misteriosamente congelata questo libro rivela finalmente che cos è successo e perché restituendo il diario segreto di un anno e tre mesi di governo del cambiamento

**I insostenibile leggerezza del governo del cambia pdf** - Oct 07 2023

web quaderni dell osservatorio sulla rappresentanza dei cittadini istituzioni e dinamiche del diritto I insostenibile leggerezza del governo del cambiamento I horror vacui nel giudizio sulle leggi prassi e tecniche decisionali utilizzate dalla corte costituzionale allo scopo di ovviare all inerzia del legislatore il governo del sociale

**I insostenibile leggerezza del governo del cambia stuart p** - Sep 25 2022

web I insostenibile leggerezza del governo del cambia recognizing the exaggeration ways to get this book I insostenibile leggerezza del governo del cambia is additionally useful you have remained in right site to start getting this info acquire the I insostenibile leggerezza del governo del cambia colleague that we give here and check out the link

**cambiamento climatico e insostenibile leggerezza del governo** - May 22 2022

web sep 25 2020 cambiamento climatico e insostenibile leggerezza del governo con valori compresi tra lo 0 5 e l 8 del pil a fine secolo i cambiamenti climatici aumenteranno la disuguaglianza economica tra le regioni e tutti i settori dell economia italiana risulteranno impattati negativamente mentre le perdite maggiori si

**amazon it I insostenibile leggerezza del governo del cambiamento I** - Jun 03 2023

web compra I insostenibile leggerezza del governo del cambiamento spedizione gratuita su ordini idonei amazon it I insostenibile leggerezza del governo del cambiamento I interno del ministro libri

**I insostenibile leggerezza del governo del cambiamento** - Feb 28 2023

web I insostenibile leggerezza del governo del cambiamento è un libro di I interno del ministro pubblicato da utet acquista su ibs a 12 00

**I insostenibile leggerezza del governo del cambiamento** - Apr 01 2023

web I insostenibile leggerezza del governo del cambiamento è un ebook di I interno del ministro pubblicato da utet a 7 99 il file è in formato epub2 con drmfree risparmia online con le offerte ibs

**I insostenibile leggerezza del governo del cambia pdf** - Feb 16 2022

web jun 27 2023 this I insostenibile leggerezza del governo del cambia as one of the most working sellers here will completely be in the course of the best options to review volevo uccidere j l godard jan nĕmec 2018 05 24 volevo uccidere j l godard è un romanzo a episodi che parte dall autobiografia dell autore per scrivere quella di un epoca

**I insostenibile leggerezza del governo del cambiamento perlego** - Oct 27 2022

web ministro I del 2019 I insostenibile leggerezza del governo del cambiamento edition unavailable deagostini libri available

at perlego com book 4217980 linsostenibile leggerezza del governo del cambiamento pdf accessed 7 october 2023

[l insostenibile leggerezza del governo del cambia copy](#) - Nov 27 2022

web l insostenibile leggerezza del governo del cambiamento feb 13 2023 nata in sordina il 6 giugno 2019 nel giro di un mese la pagina facebook l interno del ministro aveva già raccolto più di ventimila fan per i quali i post della voce interiore di matteo salvini

[l insostenibile leggerezza del governo del cambia pdf](#) - Apr 20 2022

web may 22 2023 merely said the l insostenibile leggerezza del governo del cambia is universally compatible with any devices to read essere natura andrea staid 2022 11 08t00 00 00 01 00 per secoli abbiamo considerato il pianeta come una risorsa inesauribile da sfruttare e piegare per i nostri interessi abbiamo deviato fiumi

*l insostenibile leggerezza del governo del cambia copy* - Aug 25 2022

web l insostenibile leggerezza del governo del cambia le procedure finanziarie in un sistema istituzionale multilivello lavorare è una parola legislation in europe benessere personale e benessere organizzativo un binomio possibile la cultura del lavoro come leva strategica per il successo d impresa nascita e dissoluzione della iugoslavia

**l insostenibile leggerezza del governo del cambiamento overdrive** - Jan 30 2023

web nov 12 2019 sulle soglie della crisi la pagina è rimasta misteriosamente congelata questo libro rivela finalmente che cos è successo e perché restituendo il diario segreto di un anno e tre mesi di governo del cambiamento

[l insostenibile leggerezza del governo del cambia](#) - May 02 2023

web l insostenibile leggerezza del governo del cambia multiple populisms mar 15 2020 this book provides a comprehensive interpretation of the multiple manifestations of populism using italy the only country amongst consolidated constitutional democracies in which populist political forces have been in

*linsostenibile leggerezza del governo del cambiamento l interno del* - Jul 24 2022

web acquista online linsostenibile leggerezza del governo del cambiamento di l interno del ministro in formato ebook su mondadori store

[l insostenibile leggerezza dell essere liquidi il sole 24 ore](#) - Mar 20 2022

web nov 1 2023 cambio valute contro dollaro l insostenibile leggerezza dell essere liquidi dalla durata ai finanziamenti cosa non dice il decreto del governo di alberto magnani amazon apple

[pdf l insostenibile leggerezza del governo del cambia](#) - Sep 06 2023

web l insostenibile leggerezza del governo del cambiamento jul 23 2023 nata in sordina il 6 giugno 2019 nel giro di un mese la pagina facebook l interno del ministro aveva già raccolto più di ventimila fan per i quali i post della voce interiore di matteo salvini

*amazon com au customer reviews oma erzähl mir von dir das - Nov 05 2022*

web find helpful customer reviews and review ratings for oma erzähl mir von dir das erinnerungsbuch zum ausfüllen at amazon com read honest and unbiased product

opa erzähl mir von dir das erinnerungsbuch zum au - Aug 02 2022

web opa erzähl mir von dir das erinnerungsbuch zum au is available in our book collection an online access to it is set as public so you can download it instantly oma and opa

oma erzähl mir von dir das erinnerungsbuch zum ausfüllen - Mar 09 2023

web oma erzähl mir von dir das erinnerungsbuch zum ausfüllen lennarz alexandra amazon com au books

*oma erzähl mir von dir das erinnerungsbuch zum au pdf* - Feb 25 2022

web 2 oma erzähl mir von dir das erinnerungsbuch zum au 2023 04 08 haben oder aber die leben doch fast ähnlich ablaufen würden wir wissen was unsere großeltern bewegt

*opa erzähl mir von dir das erinnerungsbuch zum au philippa* - Dec 26 2021

web fragebuch für erinnerungen und zum ausfüllen geschenk für großeltern zum erzählen oma und opa erzählen über dich ist ein ausfüllbuch für großeltern oma und opa

oma erzähl mal erinnerungsalbum deines lebens - Jul 01 2022

web jul 17 2016 vor kurzem kam meine enkelin die selbst schon mami eines kleinen jungen namen ben ist auf mich zu und übergab mir ein buch mit dem titel oma erzähl mal

**opa erzähl mir von dir das erinnerungsbuch zum au** - Oct 24 2021

web jul 22 2023 opa erzähl mir von dir ist ein ganz persönliches geschenk zum ausfüllen das diese erinnerungen für alle zeiten wachhält mit seinen eintragungen zu

*oma erzähl mir von dir das erinnerungsbuch zum au pdf pdf* - Sep 22 2021

web diese zehn fragen sollten enkelkinder stellen rund 120 persönliche fragen zur kindheit schulzeit dem erwachsenwerden zu erlebnissen und erfahrungen dasgeschenkbuch

*oma erzähl mir von dir das erinnerungsbuch zum au copy* - Feb 08 2023

web jul 28 2023 oma erzähl mir von dir das erinnerungsbuch zum au and numerous ebook collections from fictions to scientific research in any way in the middle of them is this

*oma erzähl mir von dir das ausfüllbuch für großmütter* - Dec 06 2022

web oma erzähl mir von dir das ausfüllbuch für großmütter erinnerungen und geschichten eines lebens geschenk für oma books n love isbn 9798454472825 kostenloser

*oma erzähl mir von dir das erinnerungsbuch zum au pdf copy* - Mar 29 2022

web oma erzähl uns deine geschichten erinnerungsbuch zum eintragen mit über 100 seiten persönliche fragen die zum nachdenken anregen erfahre tolle geschichten die du

*oma erzähl mir von dir das ausfüllbuch für großmütter* - May 11 2023

web oma erzähl mir von dir das ausfüllbuch für großmütter erinnerungen und geschichten eines lebens geschenk für oma gebundene ausgabe 12 august 2022 von books n

**opa erzähl mir von dir das erinnerungsbuch zum au full pdf** - Jan 27 2022

web opa erzähl mir von dir das erinnerungsbuch zum au downloaded from dotnbm com by guest strickland lin wall street titan der börsenhai holt mcdougal vom

**oma erzähl mir von dir das erinnerungsbuch zum au pdf** - Sep 03 2022

web das geheimnis der letzten schäferin oma erzähl mir von dir das erinnerungsbuch zum au downloaded from ftp popcake com by guest dario lopez ein falscher traum von

*oma erzähl mir von dir das erinnerungsbuch zum ausfüllen* - Jun 12 2023

web ein erinnerungsbuch zum ausfüllen mit 148 wunderschön gestalteten seiten zum ausfüllen bemalen und bekleben fünf themenblöcke kindheit und jugend liebe und

**oma erzähl mir von dir das erinnerungsbuch zum ausfüllen** - Aug 14 2023

web oma ist die beste und ihre erinnerungen sind ein kostbarer schatz oma erzähl mir von dir ist ein ganz persönliches ausfüllbuch für großmütter und ihre enkelkinder das buch

**oma erzähl mir von dir das erinnerungsbuch zum au** - May 31 2022

web oma erzähl mir von dir das erinnerungsbuch zum au 1 oma erzähl mir von dir das erinnerungsbuch zum au geteilte träume der angler hatte einen köter ins wasser

**oma erzähl mir von dir das erinnerungsbuch zum au kristin** - Jul 13 2023

web oma erzähl mir von dir das erinnerungsbuch zum au recognizing the pretentiousness ways to acquire this book oma erzähl mir von dir das erinnerungsbuch zum au is

**oma erzähl mir von dir das erinnerungsbuch zum ausfüllen** - Apr 10 2023

web oma erzähl mir von dir das erinnerungsbuch zum ausfüllen oma was kannst du mir von dir erzählen team oma isbn kostenloser versand für alle bücher mit

**oma erzähl mir von dir das erinnerungsbuch zum au pdf** - Oct 04 2022

web oma erzähl mir von dir das erinnerungsbuch zum au mama erzähl mir von dir apr 24 2023 mama ich möchte deine geschichte hören ist die perfekte möglichkeit für deine

**oma erzähl mir von dir das erinnerungsbuch zum ausfüllen by** - Apr 29 2022

web oma erzähl mir von dir das erinnerungsbuch zum ausfüllen june 2nd 2020 oma erzähl mir von dir das erinnerungsbuch zum ausfüllen opa erzähl aus deinem leben ein ganz

**oma erzähl mir von dir das erinnerungsbuch zum au** - Nov 24 2021

web jul 31 2023 declaration oma erzähl mir von dir das erinnerungsbuch zum au that you are looking for it will extremely squander the time however below subsequent to you

oma erzähl mir von dir das erinnerungsbuch zum au buch - Jan 07 2023

web oma erzähl mir von dir das erinnerungsbuch zum au buch zustand sehr gut so macht sparen spaß bis zu 70 ggü neupreis verkauft siehe ähnliche artikel eur