

Civil Engineering Basic Knowledge - Formulas

Basic Formulas | Interview Question and Answers | Site Knowledge | QS Knowledge

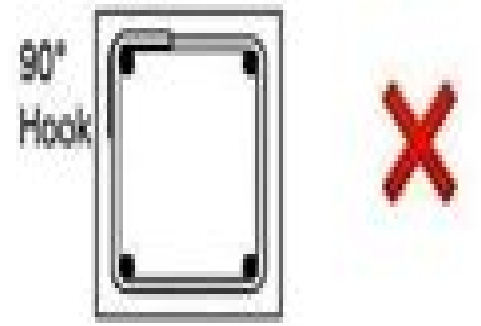

Column

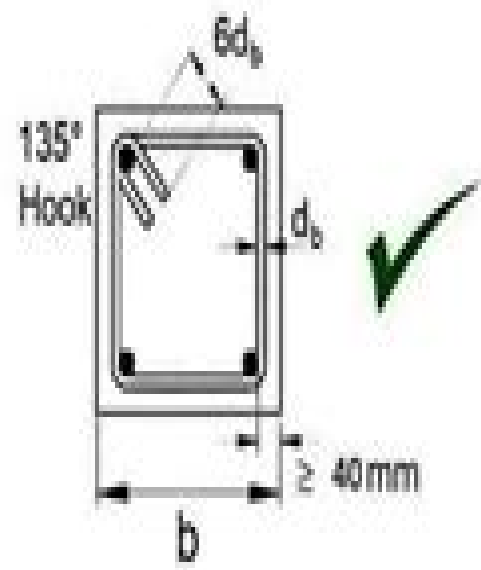
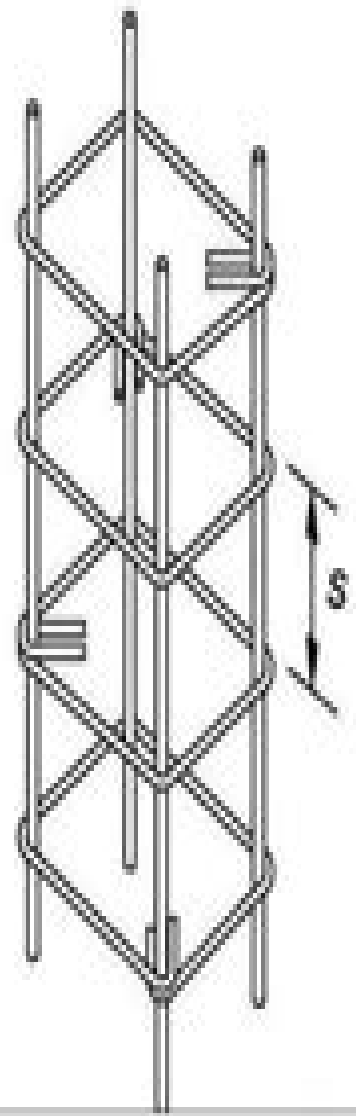
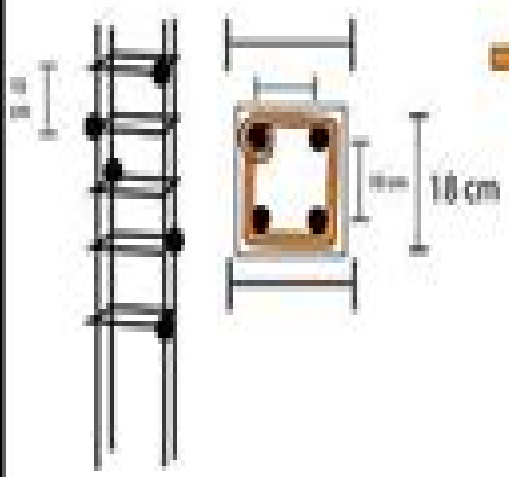

Overlap

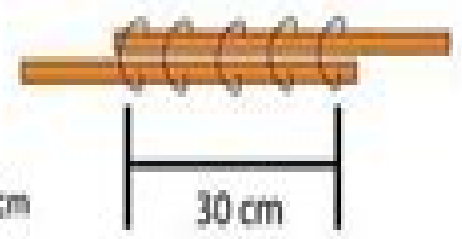

Beam

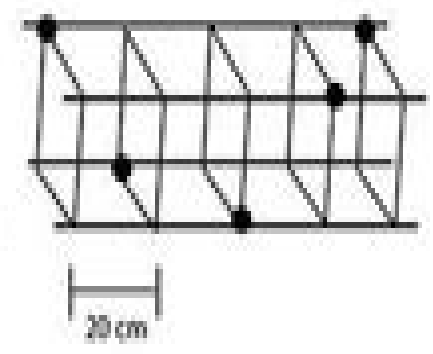
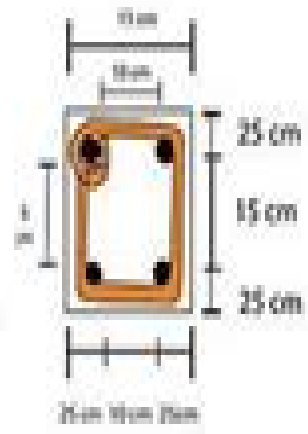

Basic Civil Engineering By Kv Natarajan

RD Boyd



Basic Civil Engineering By Kv Natarajan:

Basic Mechanical Engineering T. S. Rajan, 2007 The Book Provides A Glimpse Of The Fascinating Field Of Mechanical Engineering To The Entrants To Engineering Colleges It Gives An Insight Into The Major Areas Of Mechanical Engineering Like Power Production Energy Alternatives Production Alternatives And The Latest Computer Controlled Machine Tools The Book Is Made Interesting With Numerous Sketches And Schematics A Definite Advantage In Understanding The Subject

Indian Books in Print ,2003 Publisher's Monthly ,1993 **The Indian Journal of Technical Education** ,1972

International Books in Print ,1991 **The Civil List of Indian Administrative Service** ,1973 The Indian Concrete Journal ,1992 **Fundamentals of Structural Analysis, 2nd Edition** Roy, Sujit Kumar & Chakrabarty Subrata, 2003 For B E B Tech in Civil Engineering and also useful for M E M Tech students The book takes an integral look at structural engineering starting with fundamentals and ending with computer analysis This book is suitable for 5th 6th and 7th semesters of undergraduate course In this edition a new chapter on plastic analysis has been added A large number of examples have been worked out in the book so that students can master the subject by practising the examples and problems

The Indian and Eastern Engineer ,1959 Universities Handbook ,1997 International Handbook of Universities ,2010 *Basic Civil Engineering* Satheesh Gopi, Gopi, 2009-09 Basic Civil Engineering is designed to enrich the preliminary conceptual knowledge about civil engineering to the students of non civil branches of engineering The coverage includes materials for construction building construction basic surveying and other major topics like environmental engineering geo technical engineering transport traffic and urban engineering irrigation water supply engineering and CAD

Undergraduate Study University of Illinois at Chicago Circle, 1956 **Earth & Astronomical Sciences Research Centres** ,1995 *Earth & Astronomical Sciences Research Centres* [Anonymus AC01429856], 1995 **Current Engineering Practice** ,1960 Journal of the Institution of Engineers (India) ., 1978 **Indian Science Abstracts** ,1989 **Subject Guide to Books in Print** ,1971 **Cumulative Index to ASCE Publications** American Society of Civil Engineers, 1960

If you ally need such a referred **Basic Civil Engineering By Kv Natarajan** ebook that will have enough money you worth, get the very best seller from us currently from several preferred authors. If you desire to entertaining books, lots of novels, tale, jokes, and more fictions collections are as well as launched, from best seller to one of the most current released.

You may not be perplexed to enjoy all books collections Basic Civil Engineering By Kv Natarajan that we will utterly offer. It is not vis--vis the costs. Its more or less what you infatuation currently. This Basic Civil Engineering By Kv Natarajan, as one of the most effective sellers here will unquestionably be accompanied by the best options to review.

<https://py.bijouxmedusa.com/book/detail/default.aspx/pediatric%20advanced%20life%20support%20pals%20provider%20manual.pdf>

Table of Contents Basic Civil Engineering By Kv Natarajan

1. Understanding the eBook Basic Civil Engineering By Kv Natarajan
 - The Rise of Digital Reading Basic Civil Engineering By Kv Natarajan
 - Advantages of eBooks Over Traditional Books
2. Identifying Basic Civil Engineering By Kv Natarajan
 - Exploring Different Genres
 - Considering Fiction vs. Non-Fiction
 - Determining Your Reading Goals
3. Choosing the Right eBook Platform
 - Popular eBook Platforms
 - Features to Look for in an Basic Civil Engineering By Kv Natarajan
 - User-Friendly Interface
4. Exploring eBook Recommendations from Basic Civil Engineering By Kv Natarajan
 - Personalized Recommendations
 - Basic Civil Engineering By Kv Natarajan User Reviews and Ratings
 - Basic Civil Engineering By Kv Natarajan and Bestseller Lists

5. Accessing Basic Civil Engineering By Kv Natarajan Free and Paid eBooks
 - Basic Civil Engineering By Kv Natarajan Public Domain eBooks
 - Basic Civil Engineering By Kv Natarajan eBook Subscription Services
 - Basic Civil Engineering By Kv Natarajan Budget-Friendly Options
6. Navigating Basic Civil Engineering By Kv Natarajan eBook Formats
 - ePub, PDF, MOBI, and More
 - Basic Civil Engineering By Kv Natarajan Compatibility with Devices
 - Basic Civil Engineering By Kv Natarajan Enhanced eBook Features
7. Enhancing Your Reading Experience
 - Adjustable Fonts and Text Sizes of Basic Civil Engineering By Kv Natarajan
 - Highlighting and Note-Taking Basic Civil Engineering By Kv Natarajan
 - Interactive Elements Basic Civil Engineering By Kv Natarajan
8. Staying Engaged with Basic Civil Engineering By Kv Natarajan
 - Joining Online Reading Communities
 - Participating in Virtual Book Clubs
 - Following Authors and Publishers Basic Civil Engineering By Kv Natarajan
9. Balancing eBooks and Physical Books Basic Civil Engineering By Kv Natarajan
 - Benefits of a Digital Library
 - Creating a Diverse Reading Collection Basic Civil Engineering By Kv Natarajan
10. Overcoming Reading Challenges
 - Dealing with Digital Eye Strain
 - Minimizing Distractions
 - Managing Screen Time
11. Cultivating a Reading Routine Basic Civil Engineering By Kv Natarajan
 - Setting Reading Goals Basic Civil Engineering By Kv Natarajan
 - Carving Out Dedicated Reading Time
12. Sourcing Reliable Information of Basic Civil Engineering By Kv Natarajan
 - Fact-Checking eBook Content of Basic Civil Engineering By Kv Natarajan
 - Distinguishing Credible Sources
13. Promoting Lifelong Learning

- Utilizing eBooks for Skill Development
 - Exploring Educational eBooks
14. Embracing eBook Trends
- Integration of Multimedia Elements
 - Interactive and Gamified eBooks

Basic Civil Engineering By Kv Natarajan Introduction

In the digital age, access to information has become easier than ever before. The ability to download Basic Civil Engineering By Kv Natarajan has revolutionized the way we consume written content. Whether you are a student looking for course material, an avid reader searching for your next favorite book, or a professional seeking research papers, the option to download Basic Civil Engineering By Kv Natarajan has opened up a world of possibilities. Downloading Basic Civil Engineering By Kv Natarajan provides numerous advantages over physical copies of books and documents. Firstly, it is incredibly convenient. Gone are the days of carrying around heavy textbooks or bulky folders filled with papers. With the click of a button, you can gain immediate access to valuable resources on any device. This convenience allows for efficient studying, researching, and reading on the go. Moreover, the cost-effective nature of downloading Basic Civil Engineering By Kv Natarajan has democratized knowledge. Traditional books and academic journals can be expensive, making it difficult for individuals with limited financial resources to access information. By offering free PDF downloads, publishers and authors are enabling a wider audience to benefit from their work. This inclusivity promotes equal opportunities for learning and personal growth. There are numerous websites and platforms where individuals can download Basic Civil Engineering By Kv Natarajan. These websites range from academic databases offering research papers and journals to online libraries with an expansive collection of books from various genres. Many authors and publishers also upload their work to specific websites, granting readers access to their content without any charge. These platforms not only provide access to existing literature but also serve as an excellent platform for undiscovered authors to share their work with the world. However, it is essential to be cautious while downloading Basic Civil Engineering By Kv Natarajan. Some websites may offer pirated or illegally obtained copies of copyrighted material. Engaging in such activities not only violates copyright laws but also undermines the efforts of authors, publishers, and researchers. To ensure ethical downloading, it is advisable to utilize reputable websites that prioritize the legal distribution of content. When downloading Basic Civil Engineering By Kv Natarajan, users should also consider the potential security risks associated with online platforms. Malicious actors may exploit vulnerabilities in unprotected websites to distribute malware or steal personal information. To protect themselves, individuals should ensure their devices have reliable antivirus software installed and validate the legitimacy of the websites they are downloading from.

In conclusion, the ability to download Basic Civil Engineering By Kv Natarajan has transformed the way we access information. With the convenience, cost-effectiveness, and accessibility it offers, free PDF downloads have become a popular choice for students, researchers, and book lovers worldwide. However, it is crucial to engage in ethical downloading practices and prioritize personal security when utilizing online platforms. By doing so, individuals can make the most of the vast array of free PDF resources available and embark on a journey of continuous learning and intellectual growth.

FAQs About Basic Civil Engineering By Kv Natarajan Books

What is a Basic Civil Engineering By Kv Natarajan PDF? A PDF (Portable Document Format) is a file format developed by Adobe that preserves the layout and formatting of a document, regardless of the software, hardware, or operating system used to view or print it. **How do I create a Basic Civil Engineering By Kv Natarajan PDF?** There are several ways to create a PDF: Use software like Adobe Acrobat, Microsoft Word, or Google Docs, which often have built-in PDF creation tools. Print to PDF: Many applications and operating systems have a "Print to PDF" option that allows you to save a document as a PDF file instead of printing it on paper. Online converters: There are various online tools that can convert different file types to PDF. **How do I edit a Basic Civil Engineering By Kv Natarajan PDF?** Editing a PDF can be done with software like Adobe Acrobat, which allows direct editing of text, images, and other elements within the PDF. Some free tools, like PDFescape or Smallpdf, also offer basic editing capabilities. **How do I convert a Basic Civil Engineering By Kv Natarajan PDF to another file format?** There are multiple ways to convert a PDF to another format: Use online converters like Smallpdf, Zamzar, or Adobe Acrobats export feature to convert PDFs to formats like Word, Excel, JPEG, etc. Software like Adobe Acrobat, Microsoft Word, or other PDF editors may have options to export or save PDFs in different formats. **How do I password-protect a Basic Civil Engineering By Kv Natarajan PDF?** Most PDF editing software allows you to add password protection. In Adobe Acrobat, for instance, you can go to "File" -> "Properties" -> "Security" to set a password to restrict access or editing capabilities. Are there any free alternatives to Adobe Acrobat for working with PDFs? Yes, there are many free alternatives for working with PDFs, such as: LibreOffice: Offers PDF editing features. PDFsam: Allows splitting, merging, and editing PDFs. Foxit Reader: Provides basic PDF viewing and editing capabilities. How do I compress a PDF file? You can use online tools like Smallpdf, ILovePDF, or desktop software like Adobe Acrobat to compress PDF files without significant quality loss. Compression reduces the file size, making it easier to share and download. Can I fill out forms in a PDF file? Yes, most PDF viewers/editors like Adobe Acrobat, Preview (on Mac), or various online tools allow you to fill out forms in PDF files by selecting text fields and entering information. Are there any restrictions when working with PDFs? Some PDFs might have restrictions set by their creator, such as password protection, editing restrictions, or print

restrictions. Breaking these restrictions might require specific software or tools, which may or may not be legal depending on the circumstances and local laws.

Find Basic Civil Engineering By Kv Natarajan :

[pediatric advanced life support pals provider manual](#)

pearson btec level 3 nationals in computing

pantone mixing guide

pathophysiology case studies

pasilyo 8 story

[pathfinder roleplaying game ultimate intrigue](#)

paper i olevel islamiyat notes

pearson physical science electromagnetic spectrum workbook

organizational behavior afsaneh malekzadeh nahavandi

[oracle goldengate 11g handbook](#)

over the moon sheet music

organizational and behavior colquitt 3rd edition

oracle banking digital experience release notes

pathfinder todhunter moon 1 angie sage

[partial differential equations for scientists and engineers farlow solutions manual](#)

Basic Civil Engineering By Kv Natarajan :

[classer dominer qui sont les autres scholarvox auf](#) - Feb 28 2022

web discover and share books you love on goodreads

classer dominer qui sont les autres christine delphy - Jul 04 2022

web l idéologie dominante nous enjoint de tolérer l autre il est question dans ce livre de divers autres de groupes opprimés et stigmatisés les femmes les homos les arabes les

classer dominer qui sont les autres babelio - Sep 18 2023

web oct 17 2008 résumé l idéologie dominante nous enjoint de tolérer l autre il est question dans ce livre de divers autres de groupes opprimés et stigmatisés les

classer dominer qui sont les autres christine delphy - Apr 01 2022

web résumé l idéologie dominante nous enjoint de tolérer l autre il est question dans ce livre de divers autres de groupes opprimés et stigmatisés les femmes les homos les

[christine delphy classer dominer qui sont les autres paris](#) - May 14 2023

web et nécessaire et s avère utile pour des féministes québécoises qui sont encore réticentes aux apports possibles de la pensée féministe postcoloniale diane lamoureux

[christine delphy classer dominer qui sont les autres](#) - Oct 19 2023

web les dominants se voient comme libres alors que les autres seraient limités par enfermés dans et résumés à leurs spécificités p 39 nommer les dominants c est les spécifier à leur tour c est usurper leur privilège p 39 et créer une égalité formelle

horoscope chinois du lundi 20 novembre 2023 journal des - Nov 27 2021

classer dominer qui sont les autres french edition ebook - Jan 10 2023

web oct 2 2008 parité combats des féministes et des homosexuels afghanistan Guantanamo loi sur le voile indigènes dans la société postcoloniale autant de

classer dominer qui sont les autres delphy christine - Jun 03 2022

web classer dominer qui sont les autres christine delphy auteur descriptif détaillé formats epub 6 99 grand format 12 20 auteur christine delphy editeur la

classer dominer qui sont les autres semantic scholar - Oct 07 2022

web classer dominer qui sont les autres format kindle de christine delphy auteur format format kindle 4 8 22 évaluations afficher tous les formats et éditions format

[classer dominer qui sont les autres scholarvox](#) - Sep 06 2022

web oct 17 2008 l idéologie dominante nous enjoint de tolérer l autre les textes de christine delphy nous montrent que celui qui n est pas un autre c est l homme et l homme

[christine delphy classer dominer qui sont les autres](#) - Oct 27 2021

[classer dominer qui sont les autres goodreads](#) - Aug 17 2023

web 3 97 228 ratings34 reviews l idéologie dominante nous enjoint de tolérer l autre les textes de christine delphy nous montrent que celui qui n est pas un autre c est l homme et

loading interface goodreads - Dec 29 2021

web les dominants se voient comme libres alors que les autres seraient limités par enfermés dans et résumés à leurs spécifiques p 39 nommer les dominants c est

classer dominer qui sont les autres recyclivre - Jan 30 2022

web 9 hours ago faites confiance à votre horoscope chinois dans ses prévisions du jour pour le 20 novembre 2023 notre expert de l'astrologie asiatique analyse le climat astral

classer dominer qui sont les autres de la france fnac - Feb 11 2023

web l'idéologie dominante nous enjoint de tolérer l'autre les textes de christine delphy nous montrent que celui qui n'est pas un autre c'est l'homme et l'homme blanc c'est sur la

amazon fr classer dominer qui sont les autres delphy - Jul 16 2023

web noté 5 retrouvez classer dominer qui sont les autres et des millions de livres en stock sur amazon fr achetez neuf ou d'occasion

classer dominer qui sont les autres livre pas cher - May 02 2022

web les textes de christine delphy nous montrent que celui qui n'est pas un autre c'est l'homme et l'homme blanc c'est sur la base du sexe de l'orientation sexuelle de la

classer dominer qui sont les autres format kindle amazon fr - Aug 05 2022

web classer dominer qui sont les autres de delphy christine isbn 10 2913372821 isbn 13 9782913372825 la fabrique 2008 couverture souple passer au

classer dominer christine delphy cairn info - Apr 13 2023

web oct 17 2008 les textes de christine delphy nous montrent que celui qui n'est pas un autre c'est l'homme et l'homme blanc c'est sur la base du sexe de l'orientation

classer dominer qui sont les autres decitre - Nov 08 2022

web l'idéologie dominante nous enjoint de tolérer l'autre les textes de christine delphy nous montrent que celui qui n'est pas un autre c'est l'homme et l'homme blanc c'est sur la

la fabrique éditions classer dominer - Dec 09 2022

web les textes de christine delphy nous montrent que celui qui n'est pas un autre c'est l'homme et l'homme blanc c'est sur la base du sexe de la religion de la couleur de

classer dominer qui sont les autres google books - Mar 12 2023

web l'injonction humaniste à les tolérer émane des uns ceux qui ont le pouvoir de nommer de classer d'envoyer des groupes entiers dans une catégorie idéologique et matérielle

classer dominer qui sont les autres delphy christine 1941 - Jun 15 2023

web sep 11 2021 1 v 227 p 17 cm l ide ologie dominante nous enjoint de tole rer l autre il est question dans ce livre de divers autres de groupes opprime s et stigmatise s les

a short history of photography english edition full pdf - Feb 28 2022

web a short history of photography english edition photography theory and practice jun 04 2020 daido moriyama mar 14 2021 inspired by the work of an earlier generation of japanese photographers especially by shomei tomatu and by william klein s seminal photographic book on new york daido moriyama moved from osaka to

photography a short critical history archive org - Dec 09 2022

web english 220 pages 25 cm three thousand copies of this revised edition were printed for the trustees of the museum of modern art by the spiral press new york in the spring of 1937 the museum of modern art held an exhibition photography 1839 1937

[a brief history of photography springerlink](#) - Jan 10 2023

web oct 4 2022 among other valuable sources josef maria eder s 1905 history of photography and particularly the renewed 1945 english edition eder 1945 was heavily used as an extremely valuable source for information on the 19th century photography

history of photography history inventions artists events - Jun 03 2022

web nov 7 2023 history of photography the treatment of the historical and aesthetic aspects of still photography photography is the method of recording an image of an object through the action of light or related radiation on a light sensitive material the word was first used in

a short history of photography by walter benjamin goodreads - Jun 15 2023

web that being said as they were written during the late 1920s and early 1930s they are amongst the earliest writings that discuss the emergence and evolution of photography as an artistic medium and the juxtaposition of photography as art with its commercial use

short history photography abebooks - Apr 01 2022

web a short history of photography by gerry badger and harvey benge and a great selection of related books art and collectibles available now at abebooks co uk

history of photography wikipedia - Nov 08 2022

web history of the camera history of photography academic journal albumen print history of photographic lens design timeline of photography technology outline of photography list of photographs considered the most important photography by indigenous peoples of the americas women photographers movie camera instant

short history of photography by harvey benge open library - Sep 06 2022

web short history of photography by harvey benge gerry badger 2008 lewis publishing dewi edition in english

on photography walter benjamin google books - Mar 12 2023

web dec 15 2015 walter benjamin reaktion books dec 15 2015 photography 156 pages walter benjamin s essay a short history of photography 1931 made bold statements about photographic pioneers

a short history of photography amazon com - Oct 19 2023

web apr 1 2008 a short history of photography collects many of the biggest names in photography and presents a picture from each well a picture from each yes but from harvey benge s own archive photographs benge has taken that have turned out to be in the manner of these great names

a short history of photography photographs by harvey benge - May 14 2023

web a short history of photography photographs by harvey benge text by gerry badger hardback 88 pages 280 x 228 mm dewi lewis publishing isbn 10 1904587518 isbn 13 978 1904587514 buy on amazon

a short history of photography by walter benjamin garage - Jul 16 2023

web a new edition of the book a joint publication between garage museum of contemporary art and ad marginem press in 2013 the anthology includes three works by german philosopher critic writer and translator walter benjamin which speculate on photography a short history of photography paris capital of the nineteenth century and the

history of photography art history oxford bibliographies - Aug 05 2022

web jul 25 2022 the history of photography is a diffuse interdisciplinary area of study written from numerous fields such as the history of art literature history of science anthropology history media and communication studies

editions of a short history of photography by walter benjamin goodreads - Aug 17 2023

web editions for a short history of photography 0956979025 kindle edition 8481916374 paperback published in 2004 1780235259 paperback published in 20

the history of photography from 1839 to the present day open - May 02 2022

web sep 18 2020 edition notes selected bibliography p 251 begun as an illustrated catalog of the exhibition photography 1839 1937 organized for the museum of modern art in 1937 in 1938 the text and illustrations were reprinted with minor revisions as photography a short critical history

the history of photography from 1839 to the present day - Jul 04 2022

web text originally published in the exhibition catalog photography 1839 1937 by the museum of modern art in 1937 in 1938 the text and ill were reprinted with minor revisions as photography a short critical history includes bibliographical references *the short story of photography a pocket guide to key genres* - Oct 07 2022

web may 8 2018 the short story of photography is a new and innovative introduction to the subject of photography simply

constructed the book explores 50 key photographs from the first experiments in the early 19th century to digital photography
a short history of photography monoskop - Sep 18 2023

web a short history of photography walter benjamin the fog surrounding the origins of photography is not quite as thick as that enveloping the beginnings of printing in the case of the former it was perhaps more obvious that the hour of invention had arrived for it had been apprehended by a number of

on photography walter benjamin google books - Apr 13 2023

web oct 15 2015 walter benjamin s 1931 essay a short history of photography is a landmark in the understanding and criticism of the medium offering surprising new takes on such photographic pioneers as
a short history of photography amazon co uk - Feb 11 2023

web buy a short history of photography first edition by harvey benge gerry badger isbn 9781904587514 from amazon s bookstore everyday low prices and free delivery on eligible orders

mercedes benz r107 560sl 1986 1989 factory workshop - Feb 15 2023

web order mercedes benz 560sl repair manual vehicle online today free same day store pickup check out free battery charging and engine diagnostic testing while you are in

mercedes benz 560sl 1986 1987 1988 1989 repair manual pdf - Aug 09 2022

web get the best deals on repair manuals literature for mercedes benz 560sl when you shop the largest online selection at ebay com free shipping on many items browse

[mercedes 560sl workshop repair manual download](#) - Apr 17 2023

web mercedes benz 560sl dealers use this official factory manual in their repair garages models mercedes 560sl languages english covers years 2018 to 2021

mercedes workshop repair owners manuals 100 free - Jun 07 2022

web this 1986 mercedes 560sl service repair manual 86 ca005872 provides detailed illustrations step by step instructions and diagrams for repair and maintenance of your

[mercedes benz 560sl 107 e56 r107 technical](#) - Mar 16 2023

web mercedes benz r107 560sl 1986 1989 factory workshop manual pdf download factory mercedes benz r107 star classic workshop manual features easy to follow

mercedes benz 560 service repair manuals on motor era - Oct 11 2022

web download the mercedes 560sl workshop manual official service and repair material for the mercedes benz with wiring part diagrams

service repair manuals for mercedes benz 560sl ebay - Dec 13 2022

web mercedes benz workshop service and repair manuals 560sl 107 048 v8 5 6l 117 967 1989 starting and charging sensors and switches starting and charging

mercedes 560se 560sel 560sec workshop repair manual - Jan 02 2022

web mercedes sl 560 service manual for roadside repairs mercedes sl 560 owners manual covering weekly checks mercedes sl 560 workshop manual covering lubricants fluids

mercedes sl 560 repair service manuals - May 18 2023

web mercedes sl 560 workshop owners service or repair manuals free no ads

mercedes 560 free workshop and repair manuals - Aug 21 2023

web mercedes 560 workshop repair and owners manuals for all years and models free pdf download for thousands of cars and trucks

1986 mercedes 560sl service repair manual 86 ca005872 - May 06 2022

web view and download mercedes benz 1989 560 sl owner s manual online 1989 560 sl automobile pdf manual download

mercedes benz 560sel repair manual online repairsurge - Mar 04 2022

web summary of contents for mercedes benz 560 sl 1986 page 1 owner s manual page 2 have all maintenance work performed at regular intervals by an authorized mercedes

mercedes benz r107 560sl service repair manual pdf - Sep 22 2023

web 560 sl service repair manuals mercedes benz r107 560sl roadster manuals the r107 sl was a two seat car with a detachable roof it replaced the w113 sl class in

mercedes benz 560 sl 1986 automobile owner s - Feb 03 2022

web official mercedes benz 560se 560sel 560sec workshop manual is the complete service repair manual containing comprehensive illustrations and wiring diagrams

mercedes benz workshop service and repair manuals - Nov 12 2022

web motor era offers service repair manuals for your mercedes benz 560 download your manual now mercedes benz 560 service repair manuals complete list of mercedes

mercedes sl 560 repair service manuals - Dec 01 2021

[mercedes 560 repair service manuals 19 pdf s](#) - Jul 20 2023

web mercedes 560 owners manual covering weekly checks mercedes 560 workshop manual covering lubricants fluids and tyre pressures mercedes 560 service pdf s covering

mercedes benz 560sl repair manual vehicle autozone - Jan 14 2023

web get the best deals on service repair manuals for mercedes benz 560sl when you shop the largest online selection at ebay com free shipping on many items browse your

repair manuals literature for mercedes benz 560sl ebay - Jul 08 2022

web our mercedes automotive repair manuals are split into five broad categories mercedes workshop manuals mercedes owners manuals mercedes wiring diagrams

mercedes benz 1989 560 sl owner s manual pdf - Apr 05 2022

web your online mercedes benz 560sel repair manual lets you do the job yourself and save a ton of money no more eye popping bills at the repair shop your manual pays for itself

mercedes sl 560 free workshop and repair manuals - Oct 23 2023

web mercedes sl 560 workshop repair and owners manuals for all years and models free pdf download for thousands of cars and trucks

mercedes sl class 560sl workshop repair manual download - Sep 10 2022

web description whats included faq this is an original factory service and repair manual for 1986 1987 1988 1989 mercedes benz 560sl contains high quality images circuit

mercedes sl 560 1986 1989 workshop manual pdf - Jun 19 2023

web drawings diagrams step by step guides explanations of mercedes sl 560 service repair maintenance download free mercedes sl 560 mercedes sl 560 1986 1989 workshop