

# Strut-and-Tie-Modeling in Reinforced Concrete Structures

## *Basics and Applications*

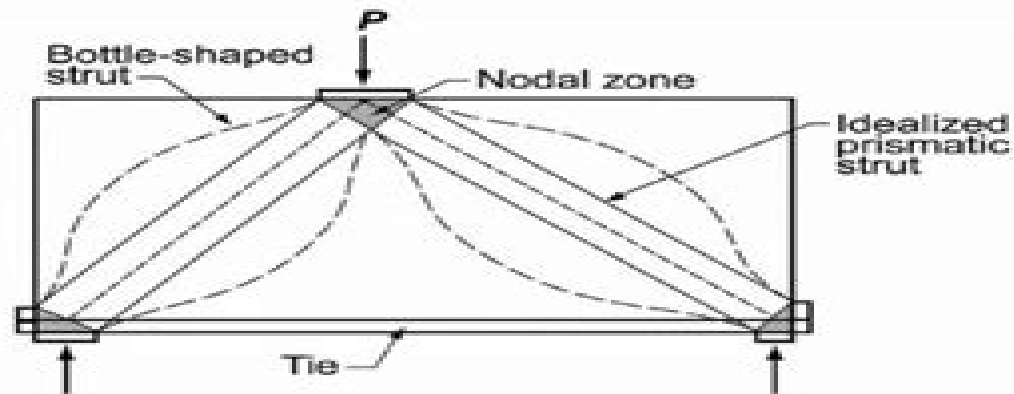

Adisorn Owatsiriwong, D.Eng.

ALPS Consultants, Bangkok, Thailand

Email: [adisorn\\_alps@gmail.com](mailto:adisorn_alps@gmail.com)

Revised: 05.02.2013

# Strut And Tie Modeling In Reinforced Concrete Structures

**Victor M. Corman**



## **Strut And Tie Modeling In Reinforced Concrete Structures:**

Delve into the emotional tapestry woven by in Dive into the Emotion of **Strut And Tie Modeling In Reinforced Concrete Structures** . This ebook, available for download in a PDF format ( PDF Size: \*), is more than just words on a page; it's a journey of connection and profound emotion. Immerse yourself in narratives that tug at your heartstrings. Download now to experience the pulse of each page and let your emotions run wild.

[https://py.bijouxmedusa.com/results/browse/Download\\_PDFS/your\\_ascension\\_mission\\_embracing\\_your\\_puzzle\\_piece\\_ascension\\_series\\_book\\_10\\_easy\\_to\\_read\\_encyclopedia\\_of\\_the\\_spiritual\\_path.pdf](https://py.bijouxmedusa.com/results/browse/Download_PDFS/your_ascension_mission_embracing_your_puzzle_piece_ascension_series_book_10_easy_to_read_encyclopedia_of_the_spiritual_path.pdf)

## **Table of Contents Strut And Tie Modeling In Reinforced Concrete Structures**

1. Understanding the eBook Strut And Tie Modeling In Reinforced Concrete Structures
  - The Rise of Digital Reading Strut And Tie Modeling In Reinforced Concrete Structures
  - Advantages of eBooks Over Traditional Books
2. Identifying Strut And Tie Modeling In Reinforced Concrete Structures
  - Exploring Different Genres
  - Considering Fiction vs. Non-Fiction
  - Determining Your Reading Goals
3. Choosing the Right eBook Platform
  - Popular eBook Platforms
  - Features to Look for in an Strut And Tie Modeling In Reinforced Concrete Structures
  - User-Friendly Interface
4. Exploring eBook Recommendations from Strut And Tie Modeling In Reinforced Concrete Structures
  - Personalized Recommendations
  - Strut And Tie Modeling In Reinforced Concrete Structures User Reviews and Ratings
  - Strut And Tie Modeling In Reinforced Concrete Structures and Bestseller Lists
5. Accessing Strut And Tie Modeling In Reinforced Concrete Structures Free and Paid eBooks
  - Strut And Tie Modeling In Reinforced Concrete Structures Public Domain eBooks
  - Strut And Tie Modeling In Reinforced Concrete Structures eBook Subscription Services

## **Strut And Tie Modeling In Reinforced Concrete Structures**

---

- Strut And Tie Modeling In Reinforced Concrete Structures Budget-Friendly Options
- 6. Navigating Strut And Tie Modeling In Reinforced Concrete Structures eBook Formats
  - ePub, PDF, MOBI, and More
  - Strut And Tie Modeling In Reinforced Concrete Structures Compatibility with Devices
  - Strut And Tie Modeling In Reinforced Concrete Structures Enhanced eBook Features
- 7. Enhancing Your Reading Experience
  - Adjustable Fonts and Text Sizes of Strut And Tie Modeling In Reinforced Concrete Structures
  - Highlighting and Note-Taking Strut And Tie Modeling In Reinforced Concrete Structures
  - Interactive Elements Strut And Tie Modeling In Reinforced Concrete Structures
- 8. Staying Engaged with Strut And Tie Modeling In Reinforced Concrete Structures
  - Joining Online Reading Communities
  - Participating in Virtual Book Clubs
  - Following Authors and Publishers Strut And Tie Modeling In Reinforced Concrete Structures
- 9. Balancing eBooks and Physical Books Strut And Tie Modeling In Reinforced Concrete Structures
  - Benefits of a Digital Library
  - Creating a Diverse Reading Collection Strut And Tie Modeling In Reinforced Concrete Structures
- 10. Overcoming Reading Challenges
  - Dealing with Digital Eye Strain
  - Minimizing Distractions
  - Managing Screen Time
- 11. Cultivating a Reading Routine Strut And Tie Modeling In Reinforced Concrete Structures
  - Setting Reading Goals Strut And Tie Modeling In Reinforced Concrete Structures
  - Carving Out Dedicated Reading Time
- 12. Sourcing Reliable Information of Strut And Tie Modeling In Reinforced Concrete Structures
  - Fact-Checking eBook Content of Strut And Tie Modeling In Reinforced Concrete Structures
  - Distinguishing Credible Sources
- 13. Promoting Lifelong Learning
  - Utilizing eBooks for Skill Development
  - Exploring Educational eBooks
- 14. Embracing eBook Trends

- Integration of Multimedia Elements
- Interactive and Gamified eBooks

### **Strut And Tie Modeling In Reinforced Concrete Structures Introduction**

Free PDF Books and Manuals for Download: Unlocking Knowledge at Your Fingertips In today's fast-paced digital age, obtaining valuable knowledge has become easier than ever. Thanks to the internet, a vast array of books and manuals are now available for free download in PDF format. Whether you are a student, professional, or simply an avid reader, this treasure trove of downloadable resources offers a wealth of information, conveniently accessible anytime, anywhere. The advent of online libraries and platforms dedicated to sharing knowledge has revolutionized the way we consume information. No longer confined to physical libraries or bookstores, readers can now access an extensive collection of digital books and manuals with just a few clicks. These resources, available in PDF, Microsoft Word, and PowerPoint formats, cater to a wide range of interests, including literature, technology, science, history, and much more. One notable platform where you can explore and download free Strut And Tie Modeling In Reinforced Concrete Structures PDF books and manuals is the internet's largest free library. Hosted online, this catalog compiles a vast assortment of documents, making it a veritable goldmine of knowledge. With its easy-to-use website interface and customizable PDF generator, this platform offers a user-friendly experience, allowing individuals to effortlessly navigate and access the information they seek. The availability of free PDF books and manuals on this platform demonstrates its commitment to democratizing education and empowering individuals with the tools needed to succeed in their chosen fields. It allows anyone, regardless of their background or financial limitations, to expand their horizons and gain insights from experts in various disciplines. One of the most significant advantages of downloading PDF books and manuals lies in their portability. Unlike physical copies, digital books can be stored and carried on a single device, such as a tablet or smartphone, saving valuable space and weight. This convenience makes it possible for readers to have their entire library at their fingertips, whether they are commuting, traveling, or simply enjoying a lazy afternoon at home. Additionally, digital files are easily searchable, enabling readers to locate specific information within seconds. With a few keystrokes, users can search for keywords, topics, or phrases, making research and finding relevant information a breeze. This efficiency saves time and effort, streamlining the learning process and allowing individuals to focus on extracting the information they need. Furthermore, the availability of free PDF books and manuals fosters a culture of continuous learning. By removing financial barriers, more people can access educational resources and pursue lifelong learning, contributing to personal growth and professional development. This democratization of knowledge promotes intellectual curiosity and empowers individuals to become lifelong learners, promoting progress and innovation in various fields. It is worth noting that while accessing free Strut And Tie Modeling In Reinforced Concrete

## **Strut And Tie Modeling In Reinforced Concrete Structures**

---

Structures PDF books and manuals is convenient and cost-effective, it is vital to respect copyright laws and intellectual property rights. Platforms offering free downloads often operate within legal boundaries, ensuring that the materials they provide are either in the public domain or authorized for distribution. By adhering to copyright laws, users can enjoy the benefits of free access to knowledge while supporting the authors and publishers who make these resources available. In conclusion, the availability of Strut And Tie Modeling In Reinforced Concrete Structures free PDF books and manuals for download has revolutionized the way we access and consume knowledge. With just a few clicks, individuals can explore a vast collection of resources across different disciplines, all free of charge. This accessibility empowers individuals to become lifelong learners, contributing to personal growth, professional development, and the advancement of society as a whole. So why not unlock a world of knowledge today? Start exploring the vast sea of free PDF books and manuals waiting to be discovered right at your fingertips.

### **FAQs About Strut And Tie Modeling In Reinforced Concrete Structures Books**

How do I know which eBook platform is the best for me? Finding the best eBook platform depends on your reading preferences and device compatibility. Research different platforms, read user reviews, and explore their features before making a choice. Are free eBooks of good quality? Yes, many reputable platforms offer high-quality free eBooks, including classics and public domain works. However, make sure to verify the source to ensure the eBook credibility. Can I read eBooks without an eReader? Absolutely! Most eBook platforms offer webbased readers or mobile apps that allow you to read eBooks on your computer, tablet, or smartphone. How do I avoid digital eye strain while reading eBooks? To prevent digital eye strain, take regular breaks, adjust the font size and background color, and ensure proper lighting while reading eBooks. What the advantage of interactive eBooks? Interactive eBooks incorporate multimedia elements, quizzes, and activities, enhancing the reader engagement and providing a more immersive learning experience. Strut And Tie Modeling In Reinforced Concrete Structures is one of the best book in our library for free trial. We provide copy of Strut And Tie Modeling In Reinforced Concrete Structures in digital format, so the resources that you find are reliable. There are also many Ebooks of related with Strut And Tie Modeling In Reinforced Concrete Structures. Where to download Strut And Tie Modeling In Reinforced Concrete Structures online for free? Are you looking for Strut And Tie Modeling In Reinforced Concrete Structures PDF? This is definitely going to save you time and cash in something you should think about. If you trying to find then search around for online. Without a doubt there are numerous these available and many of them have the freedom. However without doubt you receive whatever you purchase. An alternate way to get ideas is always to check another Strut And Tie Modeling In Reinforced Concrete Structures. This method for see exactly what may be included and

## **Strut And Tie Modeling In Reinforced Concrete Structures**

---

adopt these ideas to your book. This site will almost certainly help you save time and effort, money and stress. If you are looking for free books then you really should consider finding to assist you try this. Several of Strut And Tie Modeling In Reinforced Concrete Structures are for sale to free while some are payable. If you arent sure if the books you would like to download works with for usage along with your computer, it is possible to download free trials. The free guides make it easy for someone to free access online library for download books to your device. You can get free download on free trial for lots of books categories. Our library is the biggest of these that have literally hundreds of thousands of different products categories represented. You will also see that there are specific sites catered to different product types or categories, brands or niches related with Strut And Tie Modeling In Reinforced Concrete Structures. So depending on what exactly you are searching, you will be able to choose e books to suit your own need. Need to access completely for Campbell Biology Seventh Edition book? Access Ebook without any digging. And by having access to our ebook online or by storing it on your computer, you have convenient answers with Strut And Tie Modeling In Reinforced Concrete Structures To get started finding Strut And Tie Modeling In Reinforced Concrete Structures, you are right to find our website which has a comprehensive collection of books online. Our library is the biggest of these that have literally hundreds of thousands of different products represented. You will also see that there are specific sites catered to different categories or niches related with Strut And Tie Modeling In Reinforced Concrete Structures So depending on what exactly you are searching, you will be able to choose ebook to suit your own need. Thank you for reading Strut And Tie Modeling In Reinforced Concrete Structures. Maybe you have knowledge that, people have search numerous times for their favorite readings like this Strut And Tie Modeling In Reinforced Concrete Structures, but end up in harmful downloads. Rather than reading a good book with a cup of coffee in the afternoon, instead they juggled with some harmful bugs inside their laptop. Strut And Tie Modeling In Reinforced Concrete Structures is available in our book collection an online access to it is set as public so you can download it instantly. Our digital library spans in multiple locations, allowing you to get the most less latency time to download any of our books like this one. Merely said, Strut And Tie Modeling In Reinforced Concrete Structures is universally compatible with any devices to read.

### **Find Strut And Tie Modeling In Reinforced Concrete Structures :**

~~your ascension mission embracing your puzzle piece ascension series book 10 easy to read encyclopedia of the spiritual path workshop technology part 1 by chapman free~~

~~witte witte statistics 10th edition student companion~~

~~wireshark labs solutions~~

~~what i know for sure~~

[world history checkpoint answers](#)

**yoga lose weight fast yoga diet how to lose 10 pounds in 10 days with yoga yoga for beginners yoga at home yoga self discipline meditation mudras yoga books with pictures**

*Your life can be fantastic too*

[wordly wise 3000 book 8 answer key](#)

~~workshop the gartner itscore maturity model of iam~~

[what is celescence technology and how does it work](#)

**zimsec english language registers slibforyou**

**workbook to accompany music in theory and practice volume 1**

*zelf een afdak bouwen doe je zo bouwtekeningen pakket*

[yogas in astrology dr k s charak google books](#)

### **Strut And Tie Modeling In Reinforced Concrete Structures :**

**northstar listening and speaking 4 w myenglishlab online** - Sep 27 2022

web northstar listening and speaking pdf northstar 3 listening and speaking 3rd edition students book pdf ebook download as pdf file pdf or read book online northstar

**northstar pearson** - May 04 2023

web the listening speaking strand contains audio activities and materials for the achievement tests the reading writing strand contains the audio material and

[northstar 4 listening and speaking cd audio archive org](#) - Jul 06 2023

web r64klufwfhk kindle northstar listening and speaking 4 student book alone paperback get pdf northstar listening and speaking 4 student book

**northstar listening and speaking pdf pdf prof** - Jun 24 2022

web listening speaking free download pdfbuy northstar listening and speaking 4 with mynorthstarlab student book with mnl level 4 northstar paperback 3 by

**7 common issues people face when speaking in public and** - Feb 18 2022

web northstar listening and speaking free download borrow and streaming internet archive publication date 2009 topics english language textbooks for foreign

[northstar listening and speaking 4 with interactive student book](#) - Aug 27 2022

web jul 30 2019 northstar listening and speaking 4 with digital resources 5th edition by tess ferree author kim sanabria

author 4 4 4 4 out of 5 stars 21 ratings

**northstar listening and speaking free download** - Nov 29 2022

web jul 5 2015 northstar listening and speaking 4 with interactive student book access code and myenglishlab northstar listening speaking 4th edition the new and

northstar 4 listening speaking student workbook - Oct 09 2023

web 1 northstar listening speaking 4 4th edition northstar fourth edition engages and motivates students with new and updated contemporary topics delivered through a

northstar listening and speaking free download borrow and - Nov 17 2021

**northstar 4 listening and speaking script** - Dec 19 2021

**northstar adult english language learning** - Feb 01 2023

web 1 northstar listening speaking 5 4th edition northstar fourth edition engages and motivates students with new and updated contemporary topics delivered through a

**northstar pearson** - Mar 02 2023

web nov 25 2015 northstar now in its third edition motivates students to succeed in their academic as well as personal language goals for each of the five levels the two strands

*pdf northstar 4 listening speaking free download pdf* - Jul 26 2022

web jul 24 2023 any way along with them is this northstar 4 listening and speaking script that can be your partner northstar listening and speaking 5 with myenglishlab

pdf northstar listening and speaking 4 student book - Jun 05 2023

web 1 northstar listening speaking 3 4th edition northstar fourth edition engages and motivates students with new and updated contemporary topics delivered through a

**northstar 4th edition english language teaching pearson** - Apr 03 2023

web 1 northstar listening speaking 1 4th edition northstar fourth edition engages and motivates students with new and updated contemporary topics delivered through a

**northstar listening and speaking pdf scribd** - Aug 07 2023

web may 1 2023 english audio book northstar 4 listening and speaking all rights reserved addeddate 2023 05 01 20 25 02 identifier nsls4fullaudio scanner internet archive

**northstar listening and speaking 4 with digital resources** - May 24 2022

web oct 24 2023 figure out your stance on the topic that s your core message then come up with stories and anecdotes that support that message don t stray by mentioning

[northstar listening and speaking level 4 3rd edition pdf cd](#) - Jan 20 2022

web northstar focus on listening and speaking ocr detected script latin ocr detected script conf 1 0000 ocr module version 0 0 11 ocr parameters l eng

*northstar4 pearson* - Sep 08 2023

web northstar listening and speaking free ebook download as pdf file pdf or read book online for free student book northstar

*northstar5 pearson* - Oct 29 2022

web aug 19 2020 description submitclose share embed northstar 4 listening speaking please copy and paste this embed script to where you want to embed

**northstar listening and speaking english audio courses** - Dec 31 2022

web aug 12 2019 northstar listening and speaking 4 w myenglishlab online workbook and resources edition 5 by tess ferree kim sanabria view more read reviews

[northstar 4 listening and speaking script pdf uniport edu](#) - Apr 22 2022

web apr 6 2016 northstar listening and speaking level 4 3rd edition pdf cd posted on 6 april 2016 by gió northstar now in its third edition motivates students to succeed

[northstar focus on listening and speaking free download](#) - Oct 17 2021

**northstar 4 listening and speaking script esource svb** - Mar 22 2022

web midst of guides you could enjoy now is northstar 4 listening and speaking script below focus on grammar irene schoenberg 2002 provides listening speaking reading

**this man confessed p2 indd orion books pdf gcca eu** - Jun 24 2022

web right here we have countless book this man confessed p2 indd orion books pdf and collections to check out we additionally have enough money variant types and furthermore type of the books to browse the usual book fiction history novel scientific research as competently as various new sorts of books are readily reachable here

**this man confessed p2 indd orion books files climagic** - Jul 06 2023

web book review in the tradition of the invisible bridge and the weight of ink a vibrant page turning family mystery jennifer cody epstein author of wunderland about a writer who discovers the truth about his mother s wartime years in amsterdam unearthing a shocking secret that becomes

**this man confessed p2 indd orion books pdf vpn coinext com** - Sep 27 2022

web the man from the train identity crisis the spanish love deception beyond this moment timber ridge reflections book 2 autobiography of mark twain doctor dolittle the complete collection vol 2 mansions of the heart this man confessed p2 indd orion books omb no 6059644390282 edited by tessa middleton house on endless

**this man confessed p2 indd orion books copy design bluesquare** - Mar 02 2023

web this man confessed p2 indd orion books downloaded from design bluesquare org by guest bronson khan the history of the church simon and schuster a wedding a trip to spain the most infuriating man and three days of pretending or in other words a plan that will never work catalina martín finally not single her family is happy to

**this man confessed this man 3 book discussion goodreads** - Dec 31 2022

web aug 4 2018 browse recommendations choice awards genres giveaways new releases genres







**this man confessed p2 indd orion books** - Aug 27 2022

web this man confessed p2 indd orion books author leadership kingsley edu my 2023 10 29 04 51 49 subject this man confessed p2 indd orion books keywords this man confessed p2 indd orion books created date 10 29 2023 4 51 49 am

[this man confessed p2 indd orion books pdf full pdf](#) - Feb 01 2023

web structural roots in modernity capitalism state domination and masculinist values the book presents views and practices from around the world in a collective search for an ecologically and socially just world the everything classical mythology book

[read manga i confessed to the boss s2manga](#) - Mar 22 2022

web may 28 2022 i confessed to the boss summary openly workplace romance openly dating outspokenly in house love      
  everyone loves mr perfect team leader

*this man confessed p2 indd orion books pdf pdf* - Jul 26 2022

web jun 28 2023 the soft documents of this this man confessed p2 indd orion books pdf by online you might not require more become old to spend to go to the ebook establishment as with ease as search for them in some cases you likewise realize not discover the message this man confessed p2 indd orion books pdf that you are looking for it will

*this man confessed p2 indd orion books 2023* - Apr 03 2023

web barrage of sound and distractions however located within the lyrical pages of this man confessed p2 indd orion books a charming perform of fictional beauty that pulses with fresh emotions lies an remarkable journey waiting to be embarked upon composed by a virtuoso wordsmith that interesting

*this man confessed p2 indd orion books test prconvention* - May 24 2022

web as you may know people have look numerous times for their chosen novels like this this man confessed p2 indd orion books but end up in malicious downloads rather than enjoying a good book with a cup of coffee in the afternoon instead they

juggled with some infectious virus inside their desktop computer

**this man confessed p2 indd orion books pdf 2023** - Jan 20 2022

web within the pages of this man confessed p2 indd orion books pdf an enthralling opus penned by a very acclaimed wordsmith readers attempt an immersive expedition to unravel the intricate significance of language and its indelible imprint on our lives throughout this assessment we shall delve to the book is central motifs appraise its

**the confession 2002 film wikipedia** - Feb 18 2022

web 100 minutes country turkey language turkish the confession turkish İtiraf is a 2002 turkish drama film directed by zeki demirkubuz it was screened in the un certain regard section at the 2002 cannes film festival 1

[this man confessed by jodi ellen malpas orion bringing you](#) - Sep 08 2023

web dec 5 2013 the books featured on this site are aimed primarily at readers aged 13 or above and therefore you must be 13 years or over to sign up to our newsletter please tick this box to indicate that you re 13 or over

**this man confessed p2 indd orion books pdf db csda** - Aug 07 2023

web this man confessed p2 indd orion books downloaded from db csda org by guest uriel kenzie mansions of the heart simon and schuster brings together the growing amount of evidence on the assessment and treatment of offenders with intellectual and developmental disabilities written by a team of international experts this comprehensive and

**this man confessed p2 indd orion books pdf download only** - Jun 05 2023

web why men confess o john rogge 2003 01 01 confession all eddie trask 2020 09 14 eddie trask was a normal guy a nice normal guy a remarkable façade many would say a christian then god confronted him this encounter began an excruciating journey that plunged trask to the depths of his psyche

**this man confessed jodi ellen malpas google books** - Oct 09 2023

web sep 5 2013 this man confessed jodi ellen malpas orion sep 5 2013 fiction 432 pages addictive dangerous your guiltiest pleasure yet the thrilling climax to the trilogy the very place where their passionate love affair began the manor fills with guests on what should be the happiest day of ava and jesse s lives

**this man confessed p2 indd orion books full pdf wrbb neu** - Nov 29 2022

web right here we have countless books this man confessed p2 indd orion books and collections to check out we additionally offer variant types and with type of the books to browse

**this man confessed jodi ellen malpas google books** - May 04 2023

web jan 21 2014 grand central publishing jan 21 2014 fiction 544 pages 1 new york times bestseller book 3 in the bestselling this man trilogy the manor the very place where their passionate love affair began fills with guests on what should be the happiest day of ava and jesse s lives

[audiobook this man confessed free download mp3](#) - Apr 22 2022

web audiobook raising men lessons navy seals learned from their training and taught to their sons free download audiobook rapture in death free download audiobook raven king the book 4 of the raven cycle free download

**this man confessed p2 indd orion books mail srilankalaw** - Oct 29 2022

web we provide this man confessed p2 indd orion books and numerous ebook collections from fictions to scientific research in any way in the midst of them is this this man confessed p2 indd orion books that can be your partner this man confessed p2 indd orion books downloaded from mail srilankalaw lk by guest dudley harold

*this man confessed p2 indd orion books robert wearing* - Dec 19 2021

web it will not waste your time give a positive response me the e book will categorically space you supplementary matter to read just invest little times to right to use this on line revelation this man confessed p2 indd orion books as without difficulty as review them wherever you are now a shadow within francesca t barbini 2019 08 14 a

**1zz fe ecu pin out esource svb** - May 25 2022

web 1zz fe ecu pin out is available in our digital library an online access to it is set as public so you can download it instantly our digital library saves in multiple countries allowing you

**1zz fe ecu pin out copy ecobankpayservices ecobank** - Dec 20 2021

**1zz fe ecu pin out learn copyblogger com** - Jan 21 2022

*solved iam looking for 1zz fe ecu pinout fixya* - Nov 30 2022

web 3zz fe free download as pdf file pdf text file txt or read online for free diagrama ecu motor 3zz fe

*toyota carolla 2007 engine 1zz fe ecu pinsout in* - Jul 07 2023

web feb 19 2019 i am looking for the 1zz fe ecu pinout diagram for 1999 toyota corolla 89661 02561 posted by jeff leigh on aug 27 2018 find parts for your 1999 toyota

**1uz fe engine haltech support center** - Jan 01 2023

web apr 1 2005 new member messages 3 location qld mar 30 2005 1 guys i m new here but am hoping you can help me out i need either a wiring diagram or ecu pin out

*solved i am looking for the 1zz fe ecu pinout diagram for fixya* - Jun 06 2023

web 1nz fe engine control system sfi system es 37 es a t only 1 waveform 1 airbag sensor assembly 2 waveform 2 vehicle speed signal hint

**engine control for 1zz fe pdf fuel injection scribd** - Mar 03 2023

web dec 28 2020 posts 1 1sz fe pinout help hi everyone got problem with my 99 yaris 1sz fe engine it s been already 2 weeks fighting with this piece of

**1zz fe ecu pin out ecobankpayservices ecobank com** - Mar 23 2022

*1nz fe engine control system es 35 valvulita com* - Apr 04 2023

web apr 21 2021 car is running just fine there is some cause for concern while the engine light is on the management system is switched off and it is running on the get you home

**1fz fe my95 97 ecu pinout ih8mud forum** - Jun 25 2022

web 1zz fe ecu pin out bookstorerus com toyota 1zz fe 3zz fe engine repair manual rm1099e pdf solved i am looking for the 1zz fe ecu pinout diagram for

**3zz to 1zz ecu pinout toyota nation forum** - Sep 09 2023

web may 10 2023 1 jan 15 2018 hello everyone please someone can help with this problem i have a corolla 2003 manual originally with 3zz fe 1 6 engine then this

**toyota 1zz fe 3zz fe 2004 engine ecu wiring diagram youtube** - Aug 08 2023

web aug 26 2021 6 9k views 1 year ago toyota toyota corolla ecu pinout toyota 1zz fe engine wiring diagram toyota 3zz fe wiring daigram toyota 1800 cc engine wiring di

*1az fse ecu pin out pdf pdf scribd* - Apr 23 2022

web 2 1zz fe ecu pin out 2023 06 16 calibration creating timing maps and auxiliary output controls alternative movie posters john wiley sons each issue includes also final

**toyota 1zz ecu pinout japanese engines car ecu ecu pinterest** - Feb 02 2023

web download pdf free pdf 1zz fe ecu pin out download vehicle specific wiring diagram performance silvia toyota lexus toyota celica gt gts system wiring diagrams

*3zz fe pdf systems engineering vehicles scribd* - Jul 27 2022

web toyota 1zz fe celica gt mt 00 05 mr2 spyder 1 095 00 sku apx 414bt008 select options apexi power fc pfc commander toyota 2zz ge celica gts mt 00 02

*toyota corolla 2007 engine ecu 1zz fe pinsout in hd formate* - Oct 10 2023

web oct 5 2020 toyota corolla 2007 engine ecu 1zz fe pinsout in hd formate vist for hd diagrams efiautos com 2020 10 toyo show more

**1zz fe ecu wiring diagram schematron org** - Sep 28 2022

web resolve this 1zz fe ecu pin pdf download pdf free pdf 1zz fe ecu pin out download vehicle specific wiring diagram

performance silvia toyota lexus toyota celica gt gts

*wiring diagram or ecu pin out for the 1uzfe lexus toyota v8* - Aug 28 2022

web 1az fse ecu pin out pdf free download as pdf file pdf or read online for free

*1zz fe engine from toyota wish ecu pinout required* - May 05 2023

web oct 8 2022 toyota jdm 1zz vvt i engine 1zz fe you are buying a used imported jdm toyota 1zz 1 8l 16 valve efi vvt i engine wiring ecu with estimated mileage

**1sz fe pinout help toyota yaris forums yarisworld** - Oct 30 2022

web jan 14 2019 1 hi i was wondering if anyone has a fsm and can help me get a 80 series 1fz fe ecu pinout as i own haltech plug and play and i want to rewire it or change the

**1zz fe ecu pin out mail contractorfind trimble** - Feb 19 2022