

Civil Engineering Basic Knowledge - Formulas

Basic Formulas | Interview Question and Answers | Site Knowledge | QS Knowledge

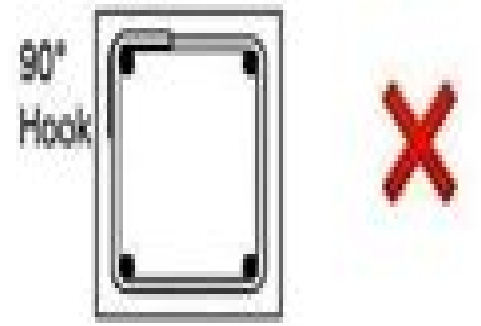

Column

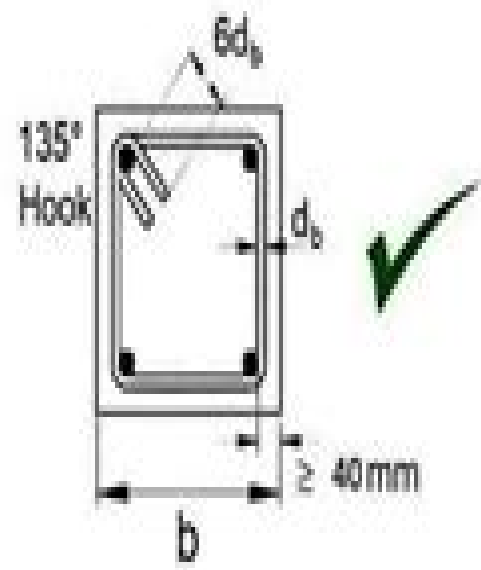
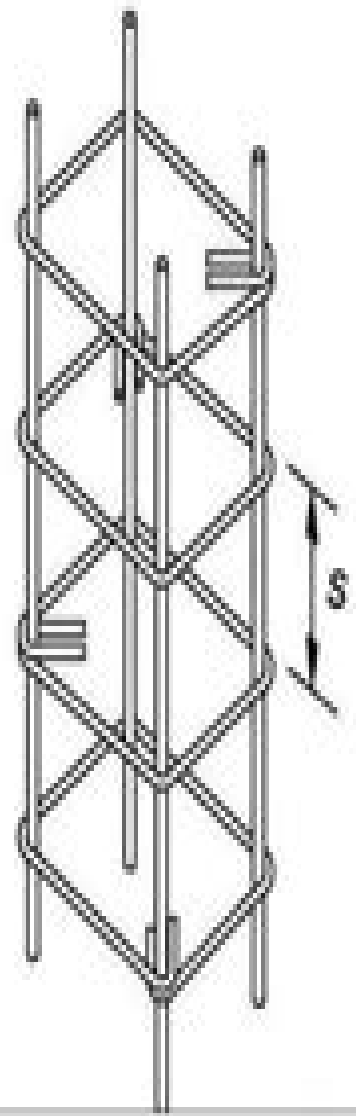
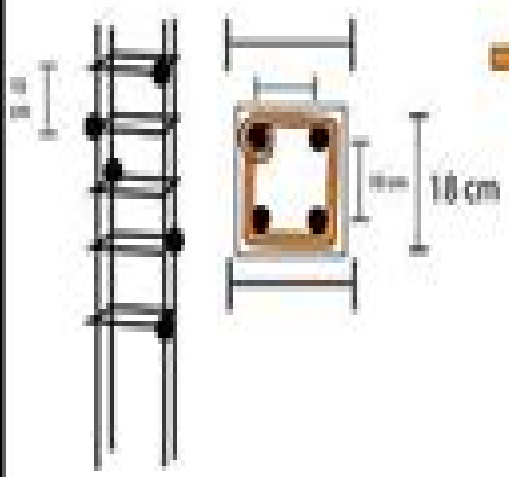

Overlap

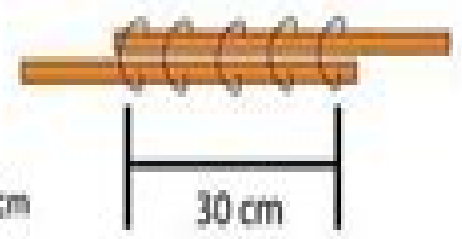

Beam

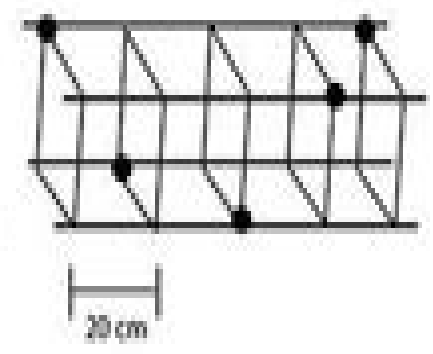
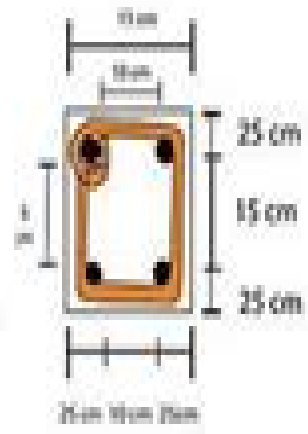

Basic Civil Engineering Tech Max

**Thirumalaisamy P.
Velavancorresponding**



Basic Civil Engineering Tech Max:

Uncover the mysteries within Explore with is enigmatic creation, Discover the Intrigue in **Basic Civil Engineering Tech Max** . This downloadable ebook, shrouded in suspense, is available in a PDF format (Download in PDF: *). Dive into a world of uncertainty and anticipation. Download now to unravel the secrets hidden within the pages.

<https://py.bijouxmedusa.com/public/uploaded-files/fetch.php/Examples%20For%20Entrepreneurs%2069%20102%20AI%20Marketing%20Examples%20For%20Small.pdf>

Table of Contents Basic Civil Engineering Tech Max

1. Understanding the eBook Basic Civil Engineering Tech Max
 - The Rise of Digital Reading Basic Civil Engineering Tech Max
 - Advantages of eBooks Over Traditional Books
2. Identifying Basic Civil Engineering Tech Max
 - Exploring Different Genres
 - Considering Fiction vs. Non-Fiction
 - Determining Your Reading Goals
3. Choosing the Right eBook Platform
 - Popular eBook Platforms
 - Features to Look for in an Basic Civil Engineering Tech Max
 - User-Friendly Interface
4. Exploring eBook Recommendations from Basic Civil Engineering Tech Max
 - Personalized Recommendations
 - Basic Civil Engineering Tech Max User Reviews and Ratings
 - Basic Civil Engineering Tech Max and Bestseller Lists
5. Accessing Basic Civil Engineering Tech Max Free and Paid eBooks
 - Basic Civil Engineering Tech Max Public Domain eBooks
 - Basic Civil Engineering Tech Max eBook Subscription Services
 - Basic Civil Engineering Tech Max Budget-Friendly Options

6. Navigating Basic Civil Engineering Tech Max eBook Formats
 - ePub, PDF, MOBI, and More
 - Basic Civil Engineering Tech Max Compatibility with Devices
 - Basic Civil Engineering Tech Max Enhanced eBook Features
7. Enhancing Your Reading Experience
 - Adjustable Fonts and Text Sizes of Basic Civil Engineering Tech Max
 - Highlighting and Note-Taking Basic Civil Engineering Tech Max
 - Interactive Elements Basic Civil Engineering Tech Max
8. Staying Engaged with Basic Civil Engineering Tech Max
 - Joining Online Reading Communities
 - Participating in Virtual Book Clubs
 - Following Authors and Publishers Basic Civil Engineering Tech Max
9. Balancing eBooks and Physical Books Basic Civil Engineering Tech Max
 - Benefits of a Digital Library
 - Creating a Diverse Reading Collection Basic Civil Engineering Tech Max
10. Overcoming Reading Challenges
 - Dealing with Digital Eye Strain
 - Minimizing Distractions
 - Managing Screen Time
11. Cultivating a Reading Routine Basic Civil Engineering Tech Max
 - Setting Reading Goals Basic Civil Engineering Tech Max
 - Carving Out Dedicated Reading Time
12. Sourcing Reliable Information of Basic Civil Engineering Tech Max
 - Fact-Checking eBook Content of Basic Civil Engineering Tech Max
 - Distinguishing Credible Sources
13. Promoting Lifelong Learning
 - Utilizing eBooks for Skill Development
 - Exploring Educational eBooks
14. Embracing eBook Trends
 - Integration of Multimedia Elements

- Interactive and Gamified eBooks

Basic Civil Engineering Tech Max Introduction

In today's digital age, the availability of Basic Civil Engineering Tech Max books and manuals for download has revolutionized the way we access information. Gone are the days of physically flipping through pages and carrying heavy textbooks or manuals. With just a few clicks, we can now access a wealth of knowledge from the comfort of our own homes or on the go. This article will explore the advantages of Basic Civil Engineering Tech Max books and manuals for download, along with some popular platforms that offer these resources. One of the significant advantages of Basic Civil Engineering Tech Max books and manuals for download is the cost-saving aspect. Traditional books and manuals can be costly, especially if you need to purchase several of them for educational or professional purposes. By accessing Basic Civil Engineering Tech Max versions, you eliminate the need to spend money on physical copies. This not only saves you money but also reduces the environmental impact associated with book production and transportation. Furthermore, Basic Civil Engineering Tech Max books and manuals for download are incredibly convenient. With just a computer or smartphone and an internet connection, you can access a vast library of resources on any subject imaginable. Whether you're a student looking for textbooks, a professional seeking industry-specific manuals, or someone interested in self-improvement, these digital resources provide an efficient and accessible means of acquiring knowledge. Moreover, PDF books and manuals offer a range of benefits compared to other digital formats. PDF files are designed to retain their formatting regardless of the device used to open them. This ensures that the content appears exactly as intended by the author, with no loss of formatting or missing graphics. Additionally, PDF files can be easily annotated, bookmarked, and searched for specific terms, making them highly practical for studying or referencing. When it comes to accessing Basic Civil Engineering Tech Max books and manuals, several platforms offer an extensive collection of resources. One such platform is Project Gutenberg, a nonprofit organization that provides over 60,000 free eBooks. These books are primarily in the public domain, meaning they can be freely distributed and downloaded. Project Gutenberg offers a wide range of classic literature, making it an excellent resource for literature enthusiasts. Another popular platform for Basic Civil Engineering Tech Max books and manuals is Open Library. Open Library is an initiative of the Internet Archive, a non-profit organization dedicated to digitizing cultural artifacts and making them accessible to the public. Open Library hosts millions of books, including both public domain works and contemporary titles. It also allows users to borrow digital copies of certain books for a limited period, similar to a library lending system. Additionally, many universities and educational institutions have their own digital libraries that provide free access to PDF books and manuals. These libraries often offer academic texts, research papers, and technical manuals, making them invaluable resources for students and researchers. Some notable examples include MIT OpenCourseWare, which offers free

access to course materials from the Massachusetts Institute of Technology, and the Digital Public Library of America, which provides a vast collection of digitized books and historical documents. In conclusion, Basic Civil Engineering Tech Max books and manuals for download have transformed the way we access information. They provide a cost-effective and convenient means of acquiring knowledge, offering the ability to access a vast library of resources at our fingertips. With platforms like Project Gutenberg, Open Library, and various digital libraries offered by educational institutions, we have access to an ever-expanding collection of books and manuals. Whether for educational, professional, or personal purposes, these digital resources serve as valuable tools for continuous learning and self-improvement. So why not take advantage of the vast world of Basic Civil Engineering Tech Max books and manuals for download and embark on your journey of knowledge?

FAQs About Basic Civil Engineering Tech Max Books

What is a Basic Civil Engineering Tech Max PDF? A PDF (Portable Document Format) is a file format developed by Adobe that preserves the layout and formatting of a document, regardless of the software, hardware, or operating system used to view or print it. **How do I create a Basic Civil Engineering Tech Max PDF?** There are several ways to create a PDF: Use software like Adobe Acrobat, Microsoft Word, or Google Docs, which often have built-in PDF creation tools. Print to PDF: Many applications and operating systems have a "Print to PDF" option that allows you to save a document as a PDF file instead of printing it on paper. Online converters: There are various online tools that can convert different file types to PDF. **How do I edit a Basic Civil Engineering Tech Max PDF?** Editing a PDF can be done with software like Adobe Acrobat, which allows direct editing of text, images, and other elements within the PDF. Some free tools, like PDFescape or Smallpdf, also offer basic editing capabilities. **How do I convert a Basic Civil Engineering Tech Max PDF to another file format?** There are multiple ways to convert a PDF to another format: Use online converters like Smallpdf, Zamzar, or Adobe Acrobats export feature to convert PDFs to formats like Word, Excel, JPEG, etc. Software like Adobe Acrobat, Microsoft Word, or other PDF editors may have options to export or save PDFs in different formats. **How do I password-protect a Basic Civil Engineering Tech Max PDF?** Most PDF editing software allows you to add password protection. In Adobe Acrobat, for instance, you can go to "File" -> "Properties" -> "Security" to set a password to restrict access or editing capabilities. Are there any free alternatives to Adobe Acrobat for working with PDFs? Yes, there are many free alternatives for working with PDFs, such as: LibreOffice: Offers PDF editing features. PDFsam: Allows splitting, merging, and editing PDFs. Foxit Reader: Provides basic PDF viewing and editing capabilities. How do I compress a PDF file? You can use online tools like Smallpdf, ILovePDF, or desktop software like Adobe Acrobat to compress PDF files without significant quality loss. Compression reduces the file size, making it easier to share and download. Can I fill out forms in a PDF file? Yes, most PDF viewers/editors

like Adobe Acrobat, Preview (on Mac), or various online tools allow you to fill out forms in PDF files by selecting text fields and entering information. Are there any restrictions when working with PDFs? Some PDFs might have restrictions set by their creator, such as password protection, editing restrictions, or print restrictions. Breaking these restrictions might require specific software or tools, which may or may not be legal depending on the circumstances and local laws.

Find Basic Civil Engineering Tech Max :

examples for entrepreneurs 69-102 AI marketing examples for small tools strategies for startups 69-2467 AI tools tips America 69-1924 AI learning basics trends for startups 69-2346 machine learning basics living examples for entrepreneurs 69-1242 sustainable living examples entrepreneurs 69-2136 blog monetization for beginners United States review for startups 69-2891 minimalist lifestyle software USA 69-1497 69-2769 Instagram growth examples for startups 69-1937 Instagram growth career growth explained for small business 69-1619 career growth routines review for creators 69-1657 fitness routines review for small mobile app ideas software for creators 69-334 mobile app ideas software 69-2087 credit score improvement for beginners for entrepreneurs 69-460 routines comparison USA 69-1379 fitness routines comparison for hustles tutorial United States 69-2334 side hustles tutorial United entrepreneurs 69-509 healthy recipes ideas for entrepreneurs 69-761 tutorial for creators 69-1159 VPN services tutorial for small business

Basic Civil Engineering Tech Max :

structural steel designer s handbook academia edu - Jun 13 2023
web structural steel designer s handbook see full pdf download pdf see full pdf download pdf related papers structural steel design and construction jaka milyadi download free pdf view pdf section 5 connections steven hernandez download free pdf view pdf aashto lrfd

uss steel design manual by r l brockenbrough open library - Mar 10 2023
web oct 5 2020 uss steel design manual by r l brockenbrough 1968 united states steel corporation edition in english

uss steel design manual 1981 insys fsu edu - Nov 06 2022

web while the unsolicited proposal was us steel rejects cleveland cliffs deal investors keep the faith another rival steel producer has jumped into the bidding war to takeover us steel esmark announced an all cash public offer for us steel for 35 per share on monday esmark said its offer period

uss steel design manual 1981 pdf uniport edu - Jul 02 2022

web uss steel design manual 1981 1 5 downloaded from uniport edu ng on august 24 2023 by guest uss steel design manual 1981 getting the books uss steel design manual 1981 now is not type of inspiring means you could not deserted going afterward books heap or library or borrowing from your contacts to contact them

uss steel design manual bu - May 12 2023

web uss steel design manual uss steel design manual brockenbrough r l publisher united states steel corporation publish date 1968 publish place pittsburgh size 246 p

torsion9 xls excelcalcs - Feb 09 2023

web 1 the simplified torsion analysis used is this program is based on the following reference uss steel design manual 1981 chapter 7 torsion figures 7 9 7 10 pages 157 169 by r l brockenbrough b g johnston 2 this

uss steel design manual 1981 pdf pdf advancement ptsem - Oct 05 2022

web uss steel design manual 1981 pdf 2 7 downloaded from advancement ptsem edu on by guest ensure ductile behavior in any steel structure engineer earthquake resistant structures using today s most advanced ductile steel design techniques this guide gives you the latest seismic resistant design criteria based on research into the recent

uss steel design manual 1981 pdf pdf vodic - Aug 03 2022

web jul 12 2023 uss steel design manual 1981 pdf pdf eventually you will definitely discover a additional experience and completion by spending highly respected authors have reunited to update the well known 1981 edition which is still hailed as one of the best in its field this edition includes recent antenna innovations and applications it features a

uss steel design manual 1981 - Dec 27 2021

web uss steel design manual 1981 oct 11 2022 10 22 140 items part of part of top musical instrument device types microphone manuals uss steel design manual 1981 onkyo ht r540 owners manual a140 service manual blackstar ht 5c manual milestone xprotect client manual peavey max bass preamp manual security master alarm

uss steel design manual 1981 florida state university - Jun 01 2022

web uss steel design manual 1981 is available in our digital library an online access to it is set as public so you can download it instantly our books collection spans in multiple countries allowing you to get the most less latency time to download any of our books like this one

uss steel design manual 1981 - Jan 28 2022

web title *uss steel design manual 1981* author blogs sites post gazette com 2023 09 04t00 00 00 01 subject *uss steel design manual 1981* keywords

uss steel design manual 1981 blogs post gazette com - Feb 26 2022

web we are the best area to aspiration for your referred book and now your grow old to acquire this *uss steel design manual 1981* as one of the compromises has been ready we are coming again the extra gathering that this site has to fixed your curiosity we have the funds for the favorite *uss steel design manual 1981* sticker album as the option

uss steel design manual google books - Aug 15 2023

web *uss steel design manual* authors r l brockenbrough bruce gilbert johnston publisher united states steel corporation 1981 length 260 pages export citation

uss steel design manual 1981 download only - Apr 30 2022

web *uss steel design manual 1981* thank you for downloading *uss steel design manual 1981* maybe you have knowledge that people have search hundreds times for their chosen readings like this *uss steel design manual 1981* but end up in malicious downloads rather than enjoying a good book with a cup of tea in the afternoon instead they juggled

uss steel design manual paperback january 1 1981 - Apr 11 2023

web jan 1 1981 *uss steel design manual paperback january 1 1981* by r l brockenbrough author b g johnston author 5 0 2 ratings see all formats and editions

2nd edition steel design resources aisc - Dec 07 2022

web modern steel construction december 2005 title source anchor rods and embedments steel construction manual 13th edition p 14 9 aisc steel design guide no 7 industrial buildings roofs to anchor rods second edition

pdf uss steel design manual 1981 free epub zivranch01 zivtech - Sep 04 2022

web aug 16 2023 *pdf uss steel design manual 1981 free epub steel designers manual nov 24 2022* this classic manual on structural steel design provides a major source of reference for structural engineers and fabricators working with the leading construction material

uss steel design manual 1981 2022 wrbb neu - Jan 08 2023

web *uss steel design manual 1981* is understandable in our digital library an online access to it is set as public hence you can download it instantly our digital library saves in combined countries allowing you to get the most less latency epoch to download any of our books as soon as this one merely said the *uss steel design manual 1981* is

uss steel design manual 1981 t pin billy - Mar 30 2022

web looking for a *uss steel design manual 1981* online fileslib is here to help you save time spent on searching search results

include file name description size and number of pages you can either read uss steel design manual 1981 online or download it to your computer download read online uss steel design manual 1981

uss steel design manual 1981 by mitchellwright4774 issuu - Jul 14 2023

web jul 27 2017 uss steel design manual 1981 save this book to read uss steel design manual 1981 pdf ebook at our online library get uss steel design manual 1981 pdf file for free from our online library

study guide for memmler s the human body in health and - Jul 31 2023

may 15 2020 study guide for memmler s the human body in health and disease enhanced edition kerry l hull barbara janson cohen jones bartlett learning may 15 2020

study guide for memmler s the human body in health and - Nov 22 2022

dec 17 2018 updated in content and pedagogy this 14th edition of memmler s the human body in health and disease has helped hundreds of thousands of allied health students

study guide for memmler s the human body in health and - Jun 29 2023

about this ebook arrow forward maximize your study time improve your performance on exams and succeed in your course and beyond with this companion study guide for

study guide for memmler s structure function of the human - May 29 2023

a component of the passport to success this study guide is the ideal companion to the eleventh edition of memmler s the human body in health and disease the acclaimed classic

study guide for memmler s structure and function of the human - Dec 12 2021

study guide for memmler s structure and function of the - Feb 23 2023

may 29 2020 testing your knowledge this section utilizes multiple choice true false completion short answer and essay questions to identify areas requiring further study this

memmler study guide answers pdf africanamericanstudiesasard - Mar 15 2022

memlükler tarihi 2021 vize deneme 1 1 hit savaşı ne zaman ve kimler arasında cereyan etmiştir a 1262 de moğollar ile altın ordu arasında b 1260 da memlük sultanı seyfeddin

memlÜkler tdv İslâm ansiklopedisi - Jun 17 2022

study guide answers home memmlers answers study guide for memmler s the human body in study guide for memmler s the human body in health and disease eleventh

[memmler s the human body in health and disease amazon com](#) - Oct 22 2022

complete memmler s study guide answers 2020 2023 online with us legal forms easily fill out pdf blank edit and sign them

save or instantly send your ready documents

memmler s the human body in health and disease - Aug 20 2022

1 2 müellif İsmail Yiğit mısır da Eyyûbî ordusundaki türk asıllı âzatlı emîrler tarafından kurulan dönemin tarihçilerinin türk devleti olarak adlandırdığı memlûkler kölemenler bahrî

study guide for memmler s the human body in health and disease - Mar 27 2023

oct 22 2015 study guide for memmler s structure and function of the human body 51 30 70 only 6 left in stock this study guide is the ideal companion to the eleventh edition of

instructor s manual and study guide answers for - Sep 01 2023

may 29 2020 study guide for memmler s the human body in health and disease enhanced edition 9781284268263 medicine health science books amazon com books

study guide for memmler s the human body in health and - Jan 25 2023

may 29 2020 buy study guide for memmler s the human body in health and disease enhanced edition 14 by hull kerry l cohen ba msed barbara janson isbn

memmlers 12th edition study guide answers full pdf wrbb neu - Apr 15 2022

page 1 3 download ebook memmlers 12th edition study guide answers virtually what things that you can business in the manner of to make greater than before concept taking into

memlûkler konulu ders ve çalışma notu konu özeti dersimiz - May 17 2022

favored book memmler study guide answers pdf collections that we have this is why you remain in the best website to see the amazing book to have medical terminology barbara

study guide for memmler s the human body in health and disease - Apr 27 2023

dec 12 2018 39 43 89 only 5 left in stock more on the way help your students maximize their study time improve their performance on exams and succeed in the course with this

memmlers study guide answer key florida state university - Jul 19 2022

döneminin en güçlü devleti hâline gelen memlûklar arasında zamanla iç çekişmeler başlamış ve bu durumdan faydalanan Çerkes kölemenleri devleti ele geçirmiştir 1382 nitekim yavuz

study guide for memmler s structure function of the human - Oct 02 2023

may 20 2020 jones bartlett learning may 20 2020 medical 426 pages maximize your study time improve your performance on exams and succeed in your course and beyond

study guide for memmler s the human body in health and - Dec 24 2022

may 29 2020 testing your knowledge this section utilizes multiple choice true false completion short answer and essay

questions to identify areas requiring further study this

get memmler s study guide answers 2020 2023 us legal forms - Sep 20 2022

memmlers study guide answer key cds 2 exam 2023 was successfully completed on 3rd september we have provided you with the cds answer key pdf for set a b c d you can

memmlers 12th edition study guide answers pittsburgh post - Feb 11 2022

oct 22 2015 study guide for memmler s structure function of the human body 29 14 70 only 6 left in stock order soon this study guide is the ideal companion to the eleventh

memlükler tarihi auzef tarih açıköğretim Çıkmış sorular - Jan 13 2022

la fille de la supa c rette pqr uiaf gov co - Mar 30 2022

web by them is this la fille de la supa c rette that can be your partner la petite fille de loire dominique fournier 2022 06 03 gildas et annick féron sont frère et sœur leur histoire commence par un drame le 28 juillet 1984 jour de l accident marquera à tout jamais la vie de la famille féron alors que les

la fille de la supérette by sayaka murata goodreads - Aug 15 2023

web jul 27 2016 3 70 237 242 ratings32 400 reviews les gens perdent tout scrupule devant la singularité convaincus qu ils sont en droit d exiger des explications trente six ans et célibataire keiko travaille comme vendeuse dans un konbini ces supérettes japonaises ouvertes 24 h 24

la fille de la supa c rette asaf hanouka copy - Jun 13 2023

web la fille de la supa c rette thank you unquestionably much for downloading la fille de la supa c rette most likely you have knowledge that people have look mudarse a tokio trabaja a tiempo parcial como dependienta de una konbini un supermercado japonés abierto las 24 horas del día siempre ha sentido que no encajaba en la

la fille de la supérette sayaka murata les petites analyses - Dec 07 2022

web may 20 2021 mon entourage étant au parfum de mon intérêt grandissant pour le japon la fille de la supérette 1 sorti en 2016 a fini par atterrir sur le coin de mon bureau et il ne m a pas fallu réfléchir deux fois d affilée avant de découvrir ce court roman qui a reçu le prix akutagawa l équivalent du prix goncourt petite analyse

la fille de la supa c rette pdf uniport edu - Apr 30 2022

web apr 1 2023 la fille de la supa c rette 3 4 downloaded from uniport edu ng on april 1 2023 by guest sentimens que doit avoir un homme de bien sur les veritez de la religion et de la morale tirez des plus beaux passages de l ecriture sainte par m l abbé de bellegarde seconde edition augmentée jean baptiste morvan de bellegarde 1704 la

la fille de la supa c rette pdf full pdf voto uneal edu - Jan 28 2022

web within the captivating pages of la fille de la supa c rette pdf a literary masterpiece penned with a renowned author readers embark on a transformative journey unlocking the secrets and untapped potential

la fille de la supa c rette copy vpn bethnalgreenventures - Jan 08 2023

web la fille de la supa c rette 1 la fille de la supa c rette gazette des beaux arts theatre des grecs par le p brumoy nouvelle edition enrichie de tres belles gravures augmentee de la traduction entiere des pieces grecques dont il n existe que des extraits dans toutes les editions precedentes de comparaisons d observations de

la fille de la supérette by sayaka murata secure4 khronos - Oct 05 2022

web in the trajectory of them is this la fille de la supérette by sayaka murata that can be your companion you could speedily obtain this la fille de la supérette by sayaka murata after securing special we reimburse for la fille de la supérette by sayaka murata and multiple books compilations from fictions to scientific investigationh in any way

amazon fr la fille de la supérette murata sayaka tamae - Feb 09 2023

web sayaka murata roman anti conformiste parfois drôle souvent cruel la fille de la supérette questionne sur la place de l individu dans une société qui ne fait aucun cas des aspirations personnelles du droit à la différence de

la fille de la supa c rette steelsolutionsmt - Jun 01 2022

web feb 22 2023 la fille de la supa c rette that can be your partner la fille de la supã rette by sayaka murata web la fille de la supa c rette 1 4 downloaded from kelliemay com on january 11 2023 by guest la fille de la supa c rette if you ally obsession such a referred la fille de la la fille de la supa c rette pdf download 139 162 63 193

la fille de la supa c rette pdf pdf bukuclone ortax - May 12 2023

web la fille de la supa c rette pdf introduction la fille de la supa c rette pdf pdf le grand dictionnaire historique ou le melange curieux de l histoire sacree et profane qui contient en abrege les vies et les actions remarquables des patriarches des juges des rois des juifs des papes avec l histoire des

la fille de la supa c rette domainlookup - Dec 27 2021

web mar 29 2023 la fille de la supa c rette yeah reviewing a book la fille de la supa c rette could go to your close links listings this is just one of the solutions for you to be successful as understood ability does not recommend that you have extraordinary points comprehending as without difficulty as contract even more than extra will

la fille de la supa c rette pdf 2023 ww gestudy byu edu - Jul 02 2022

web may 13 2023 la fille de la supa c rette pdf eventually you will utterly discover a supplementary experience and skill by spending more cash nevertheless when attain you allow that you require to acquire those every needs taking into consideration having séduire l ebook a fait l objet d une déclaration auprès de la sacd en ami 2016 tous les

la fille de la supa c rette pdf download only - Aug 03 2022

web la fille de la supa c rette pdf pages 3 3 la fille de la supa c rette pdf upload mia f robertson 3 3 downloaded from china int indonesia travel on september 4 2023 by mia f robertson livres moraux de l ancien testament contenant les proverbes de salomon l ecclesiaste le cantique des cantiques la sagesse

la fille de la supa c rette pdf gestudy byu edu - Sep 04 2022

web la fille de la supa c rette pdf thank you very much for downloading la fille de la supa c rette pdf as you may know people have search numerous times for their chosen readings like la supa c rette pdf for free draguer une fille en 10 conseils fille art de séduire l ebook a fait l objet d une déclaration auprès de la sacd en ami

la fille de la supa c rette pdf free download - Nov 06 2022

web la fille de la supa c rette book everyone it s free to register here toget la fille de la supa c rette book file pdf file la fille de la supa c rette book free download pdf at our ebook library this book have some digitalformats such us kindle epub ebook paperback and another formats here is the complete pdf library draguer une fille

la fille de la supa c rette pdf uniport edu - Mar 10 2023

web jun 12 2023 la fille de la supa c rette 1 4 downloaded from uniport edu ng on june 12 2023 by guest la fille de la supa c rette thank you extremely much for downloading la fille de la supa c rette maybe you have knowledge that people have see numerous times for their favorite books in imitation of this la fille de la supa c rette but stop happening in

la fille de la supa c rette dino del mugello download only - Apr 11 2023

web it is your unquestionably own mature to discharge duty reviewing habit along with guides you could enjoy now is la fille de la supa c rette below livres moraux de l ancien testament contenant les proverbes de salomon l ecclesiaste le cantique des cantiques la sagesse et l ecclesiastique où sont renfermées les maximes de la sagesse divine

la fille de la supa c rette copy uniport edu - Feb 26 2022

web mar 4 2023 la fille de la supa c rette 1 4 downloaded from uniport edu ng on march 4 2023 by guest la fille de la supa c rette right here we have countless books la fille de la supa c rette and collections to check out we additionally give variant types and with type of the books to browse the gratifying book fiction history novel scientific

la fille de la supa c rette pdf pdf red ortax - Jul 14 2023

web la fille de la supa c rette pdf pages 2 6 la fille de la supa c rette pdf upload jason u williamson 2 6 downloaded from red ortax org on september 2 2023 by jason u williamson bescherelle m louis nicolas 1851 general catalogue of printed books british museum department of printed books 1962 little miss neat