

Piping

Isometric

Tutorial

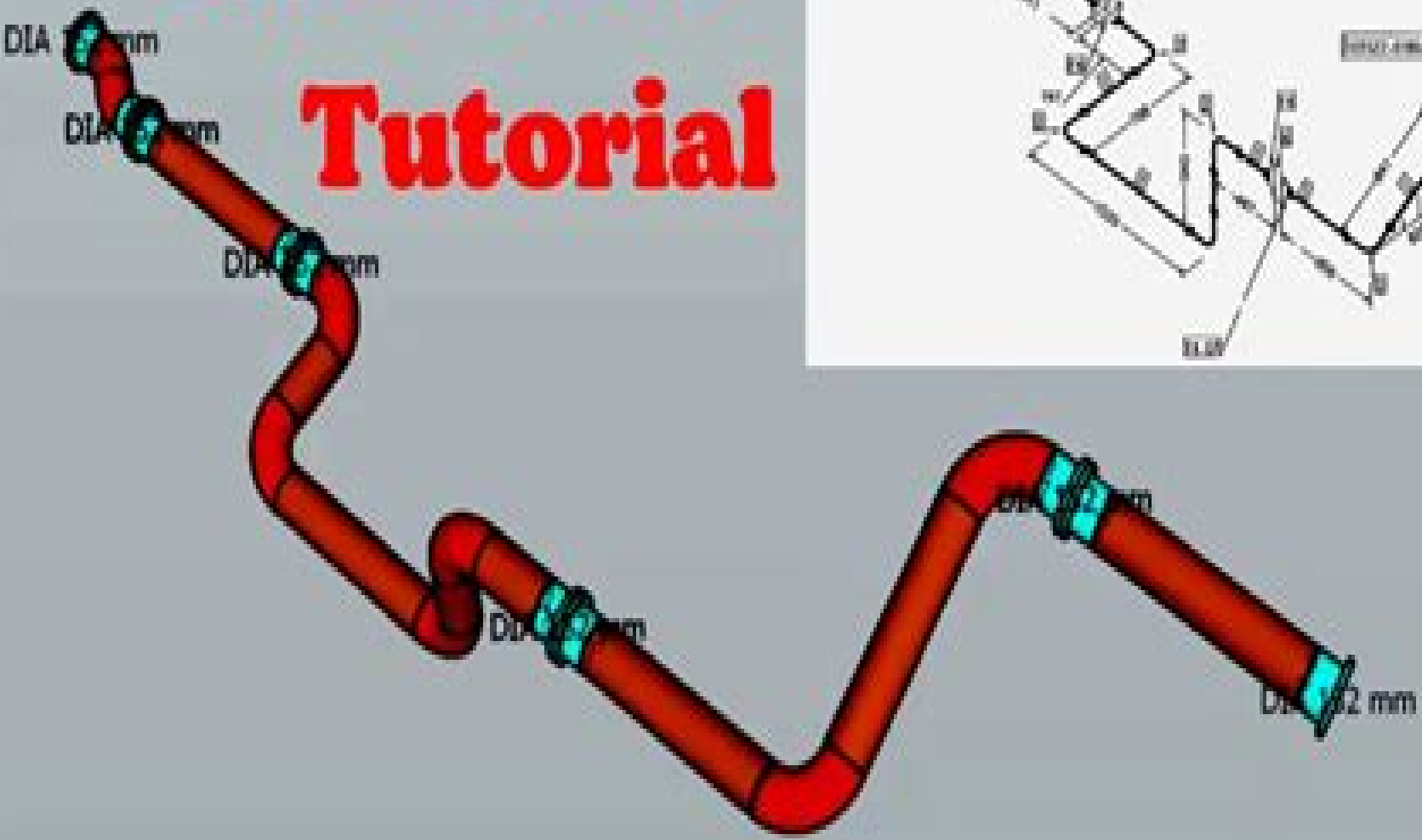
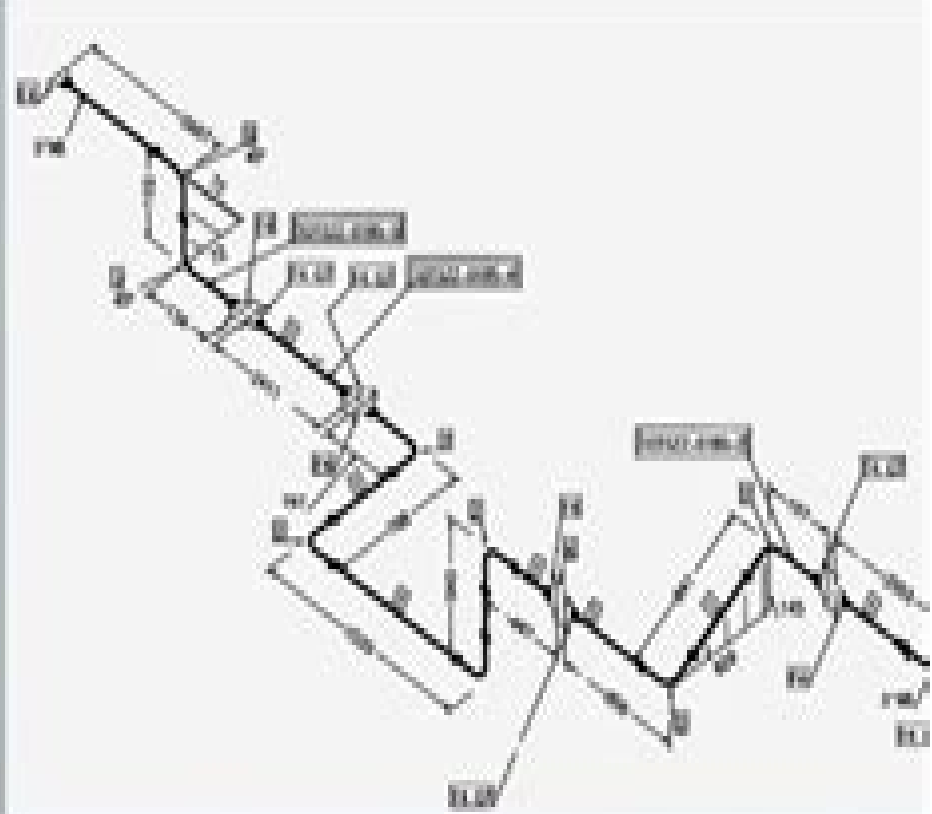

Tutorial Manual For Piping

Julia Schneider



Tutorial Manual For Piping:

Stats Cosmos Piping Applications Google Cloud Dataproc Deployment Guide Mr. Luthando Mayekiso,2018-05-25
The guide is an introductory guide to deploying piping applications on the Google Cloud Dataproc Application Programming Interface API The piping applications considered are those used for category counting property summing and property averaging in a managed cluster environment in the cloud [System Integration Guide, Query Language Reference Manual and Tutorial](#) ,1994 [A Tutorial Guide to AutoCAD 2006](#) Shawna D. Lockhart,2006 A Tutorial Guide to AutoCAD 2006 provides a step by step introduction to AutoCAD with commands taught in context In 15 clear and comprehensive sessions author Shawna Lockhart guides readers through all the important commands and techniques in AutoCAD 2006 from 2D to solid modeling In each lesson the author provides step by step instructions with frequent illustrations showing exactly what appears on the AutoCAD screen Later individual steps are no longer provided and readers are asked to apply what they ve learned by completing sequences on their own Carefully developed pedagogy reinforces this cumulative learning approach and supports readers in becoming skilled AutoCAD users Introduction to AutoCAD Basic Construction Techniques Basic Editing and Plotting Techniques Geometric Constructions Template Drawings and More Plotting 2D Orthographic Drawings Dimensioning Advanced Dimensioning Section and Auxiliary Views Blocks Design Center and Tool Palettes Introduction to Solid Modeling Changing and Plotting Solid Models Creating Assembly Drawings from Solid Models Solid Modeling for Section and Auxiliary Views Rendering **Geotechnics for Developing Africa** G.E. Blight,A.B. Fourie,G.R. Wardle,2021-06-30 The proceedings represent a valuable reference on geotechnical problems peculiar to Africa and for engineering solutions to local problems Topics covered are Foundation engineering and lateral support Methods of design and analysis Monitoring laboratory and field testing Municipal industrial and mining waste and environmental geotechnics Soil improvement Transportation geotechnics Case studies The proceedings are also an invaluable source of data on the properties of African soils the properties of residual and tropical soils as well as climate related problems [Piping Engineering Today](#) Eric Van Stijgeren,1984 **NASA Lewis Propulsion Systems Laboratory Customer Guide Manual** ,1994 [Pipeline Engineering ebook Collection](#) E.W. McAllister,W. Kent Muhlbauer,Marshall Parker,Keith Escoe,Roy A. Parisher,Mehdi Farshad,2008-09-05 Pipeline Engineering ebook Collection contains 6 of our best selling titles providing the ultimate reference for every pipeline professional s library Get access to over 3000 pages of reference material at a fraction of the price of the hard copy books This CD contains the complete ebooks of the following 6 titles McAllister Pipeline Rules of Thumb 6th Edition 9780750678520 Muhlbauer Pipeline Risk Management Manual 3rd Edition 9780750675796 Parker Pipeline Corrosion Cathodic Protection 3rd Edition 9780872011496 Escoe Piping Pipeline Assessment Guide V1 9780750678803 Parisher Pipe Drafting Design 2nd Edition 9780750674393 Farshad Plastic Pipe Systems Failure Investigation and Diagnosis 9781856174961 Six fully searchable titles on one CD providing instant access to the ULTIMATE

library of engineering materials for pipeline professionals 3000 pages of practical and theoretical pipeline information in one portable package Incredible value at a fraction of the cost of the print books

A Tutorial Guide to AutoCAD Release 14 Shawna D. Lockhart,1998 A Tutorial Guide to AutoCAD Release 14 is the ideal tool for learning the latest release of engineering s most popular design tool These tutorials take you from basics such as parts of the screen and simple command entry all the way through customizing your AutoCAD toolbars and creating your own commands In 15 clear and comprehensive sessions author Shawna Lockhart guides readers through all the important commands and techniques in AutoCAD 14 As you progress through the step by step tutorials you apply what you have learned by completing familiar sequences on your own Frequent illustrations clearly depict what you see on your screen to help you in following the steps outlined

A Tutorial Guide to AutoCAD 2000 Shawna D. Lockhart,Marc Finseth,2001 For courses in AutoCAD and Computer Aided Drawing A Tutorial Guide to AutoCAD 2000 provides a step by step introduction to AutoCAD with commands taught in context Lockhart begins this book providing step by step instructions using commands and techniques Later individual steps are no longer provided and readers are asked to apply what they have learned by completing sequences on their own Carefully developed pedagogy reinforces the cumulative learning approach and supports readers in becoming skilled AutoCAD users

CompTIA Linux+ Study Guide Roderick W. Smith,2013-01-14 Includes real world scenarios hands on exercises and access to exam prep software featuring Linux Mac and Windows Compatible test engines hundreds of sample questions electronic flashcards Cover

LPIC-1: Linux Professional Institute Certification Study Guide Roderick W. Smith,2013-01-14 Updated for the latest LPIC 1 Exams 101 and 102 The LPIC 1 certification measures your understanding of the Linux Kernel As the Linux server market continues to grow so does the demand for certified Linux administrators Prepare for the latest versions of the LPIC 1 exams 101 and 102 with the new edition of this detailed Study Guide This practical book covers key Linux administration topics and all exam objectives and includes real world examples and review questions to help you practice your skills In addition you ll gain access to a full set of online study tools including bonus practice exams electronic flashcards and more Prepares candidates to take the Linux Professional Institute exams 101 and 102 and achieve their LPIC 1 certification Covers all exam objectives and features expanded coverage on key topics in the exam Includes real world scenarios and challenging review questions Gives you online access to bonus practice exams electronic flashcards and a searchable glossary Topics include system architecture installation GNU and Unix commands Linux filesystems essential system services networking fundamentals security and more Approach the LPIC 1 certification exams with confidence with LPIC 1 Linux Professional Institute Certification Study Guide Third Edition

Heating, Piping, and Air Conditioning ,1963 Issues for Jan 1935 contain a directory of heating piping and air conditioning equipment

Professional Guide's Manual George Leonard Herter,Jacques Pierre Herter,1960

Finite element theory and its application with open source codes Anthony Pickett,2020-11-10 This book combines essential finite element FE theory

with a set of fourteen tutorials using relatively easy to use open source CAD FE and other numerical analysis codes so a student can undertake practical analysis and self study The theory covers fundamentals of the finite element method Formulation of element stiffness for one dimensional bar and beam two dimensional and three dimensional continuum elements plate and shell elements are derived based on energy and variational methods Linear nonlinear and transient dynamic solution methods are covered for both mechanical and field analysis problems with a focus on heat transfer Other important theoretical topics covered include element integration element assembly loads boundary conditions contact and a chapter devoted to material laws on elasticity hyperelasticity and plasticity A brief introduction to Computational Fluid Dynamics CFD is also included The second half of this book presents a chapter on using tutorials containing information on code installation on Windows and getting started and general hints on meshing modelling and analysis This is then followed by tutorials and exercises that cover linear nonlinear and dynamic mechanical analysis steady state and transient heat analysis field analysis fatigue buckling and frequency analysis a hydraulic pipe network analysis and lastly two tutorials on CFD simulation In each case theory is linked with application and exercises are included for further self study For these tutorials open source codes FreeCAD CalculiX FreeMAT and OpenFOAM are used CalculiX is a comprehensive FE package covering linear nonlinear and transient analysis One particular benefit is that its format and structure is based on Abaqus so knowledge gained is relevant to a leading commercial code FreeCAD is primarily a powerful CAD modelling code that includes good finite element meshing and modelling capabilities and is fully integrated with CalculiX FreeMAT is used in three tutorials for numerical analysis demonstrating algorithms for explicit finite element and CFD analysis And OpenFOAM is used for other CFD flow simulations The primary aim of this book is to provide a unified text covering theory and practice so a student can learn and experiment with these versatile and powerful analysis methods It should be of value to both finite element courses and for student self study

Plumber's and Pipe Fitter's Calculations Manual Roger Dodge Woodson,1999 Get results almost instantly without putting pencil to paper or fiddling with a calculator Packed with charts and tables that let you simply look up the answers you need this handy new tool for plumbers and pipe fitters gives you a ready source of commonly used calculations formulas and best of all solutions

Process Piping CHARLES BECHT IV.,2021 This book is based on the 2020 Edition of ASME B31 3 Process Piping Code Because changes some very significant are made to the Code every edition the reader should refer to the Code for any specific requirements This book should be considered as providing background information and not specific current Code rules The equations in this book are numbered sequentially in each chapter When equations from ASME B31 3 are reproduced herein the latter equation numbers are given as well

A Tutorial Guide to AutoCAD Release 12 Shawna D. Lockhart,1994 This book uses a tried and true tutorial approach to teach readers how to apply AutoCAD to solving engineering drawing problems This format teaches AutoCAD commands in context making it easier for readers to apply what they have learned The book contains solid Getting Started material good

coverage of views and superior coverage of dimensioning The Street Railway Journal ,1914 **Piping Materials Guide**
Peter Smith,2005-01-20 The only book of its kind on the market this book is the companion to our Valve Selection Handbook
by the same author Together these two books form the most comprehensive work on piping and valves ever written for the
process industries This book covers the entire piping process including the selection of piping materials according to the job
the application of the materials and fitting trouble shooting techniques for corrosion control inspections for OSHA
regulations and even the warehousing distributing and ordering of materials There are books on materials fitting OSHA
regulations and so on but this is the only one stop shopping source for the piping engineer on piping materials Provides a one
stop shopping source for the piping engineer on piping materials Covers the entire piping process Designed as an easy to
access guide **Chilton's Import Auto Service Manual** ,2000 Contains general information for technicians on the
specifications MIL resetting and DTC retrieval accessory drive belts timing belts brakes oxygen sensors electric cooling fans
and heater cores of twenty one types of import cars

Embark on a transformative journey with Explore the World with its captivating work, **Tutorial Manual For Piping** . This enlightening ebook, available for download in a convenient PDF format , invites you to explore a world of boundless knowledge. Unleash your intellectual curiosity and discover the power of words as you dive into this riveting creation. Download now and elevate your reading experience to new heights .

https://py.bijouxmedusa.com/data/publication/Download_PDFS/cybersecurity%20strategies%20for%20entrepreneurs%2019%201545%20cybersecurity%20tips.pdf

Table of Contents Tutorial Manual For Piping

1. Understanding the eBook Tutorial Manual For Piping
 - The Rise of Digital Reading Tutorial Manual For Piping
 - Advantages of eBooks Over Traditional Books
2. Identifying Tutorial Manual For Piping
 - Exploring Different Genres
 - Considering Fiction vs. Non-Fiction
 - Determining Your Reading Goals
3. Choosing the Right eBook Platform
 - Popular eBook Platforms
 - Features to Look for in an Tutorial Manual For Piping
 - User-Friendly Interface
4. Exploring eBook Recommendations from Tutorial Manual For Piping
 - Personalized Recommendations
 - Tutorial Manual For Piping User Reviews and Ratings
 - Tutorial Manual For Piping and Bestseller Lists
5. Accessing Tutorial Manual For Piping Free and Paid eBooks
 - Tutorial Manual For Piping Public Domain eBooks
 - Tutorial Manual For Piping eBook Subscription Services

- Tutorial Manual For Piping Budget-Friendly Options
- 6. Navigating Tutorial Manual For Piping eBook Formats
 - ePub, PDF, MOBI, and More
 - Tutorial Manual For Piping Compatibility with Devices
 - Tutorial Manual For Piping Enhanced eBook Features
- 7. Enhancing Your Reading Experience
 - Adjustable Fonts and Text Sizes of Tutorial Manual For Piping
 - Highlighting and Note-Taking Tutorial Manual For Piping
 - Interactive Elements Tutorial Manual For Piping
- 8. Staying Engaged with Tutorial Manual For Piping
 - Joining Online Reading Communities
 - Participating in Virtual Book Clubs
 - Following Authors and Publishers Tutorial Manual For Piping
- 9. Balancing eBooks and Physical Books Tutorial Manual For Piping
 - Benefits of a Digital Library
 - Creating a Diverse Reading Collection Tutorial Manual For Piping
- 10. Overcoming Reading Challenges
 - Dealing with Digital Eye Strain
 - Minimizing Distractions
 - Managing Screen Time
- 11. Cultivating a Reading Routine Tutorial Manual For Piping
 - Setting Reading Goals Tutorial Manual For Piping
 - Carving Out Dedicated Reading Time
- 12. Sourcing Reliable Information of Tutorial Manual For Piping
 - Fact-Checking eBook Content of Tutorial Manual For Piping
 - Distinguishing Credible Sources
- 13. Promoting Lifelong Learning
 - Utilizing eBooks for Skill Development
 - Exploring Educational eBooks
- 14. Embracing eBook Trends

- Integration of Multimedia Elements
- Interactive and Gamified eBooks

Tutorial Manual For Piping Introduction

Free PDF Books and Manuals for Download: Unlocking Knowledge at Your Fingertips In today's fast-paced digital age, obtaining valuable knowledge has become easier than ever. Thanks to the internet, a vast array of books and manuals are now available for free download in PDF format. Whether you are a student, professional, or simply an avid reader, this treasure trove of downloadable resources offers a wealth of information, conveniently accessible anytime, anywhere. The advent of online libraries and platforms dedicated to sharing knowledge has revolutionized the way we consume information. No longer confined to physical libraries or bookstores, readers can now access an extensive collection of digital books and manuals with just a few clicks. These resources, available in PDF, Microsoft Word, and PowerPoint formats, cater to a wide range of interests, including literature, technology, science, history, and much more. One notable platform where you can explore and download free Tutorial Manual For Piping PDF books and manuals is the internet's largest free library. Hosted online, this catalog compiles a vast assortment of documents, making it a veritable goldmine of knowledge. With its easy-to-use website interface and customizable PDF generator, this platform offers a user-friendly experience, allowing individuals to effortlessly navigate and access the information they seek. The availability of free PDF books and manuals on this platform demonstrates its commitment to democratizing education and empowering individuals with the tools needed to succeed in their chosen fields. It allows anyone, regardless of their background or financial limitations, to expand their horizons and gain insights from experts in various disciplines. One of the most significant advantages of downloading PDF books and manuals lies in their portability. Unlike physical copies, digital books can be stored and carried on a single device, such as a tablet or smartphone, saving valuable space and weight. This convenience makes it possible for readers to have their entire library at their fingertips, whether they are commuting, traveling, or simply enjoying a lazy afternoon at home. Additionally, digital files are easily searchable, enabling readers to locate specific information within seconds. With a few keystrokes, users can search for keywords, topics, or phrases, making research and finding relevant information a breeze. This efficiency saves time and effort, streamlining the learning process and allowing individuals to focus on extracting the information they need. Furthermore, the availability of free PDF books and manuals fosters a culture of continuous learning. By removing financial barriers, more people can access educational resources and pursue lifelong learning, contributing to personal growth and professional development. This democratization of knowledge promotes intellectual curiosity and empowers individuals to become lifelong learners, promoting progress and innovation in various fields. It is worth noting that while accessing free Tutorial Manual For Piping PDF books and manuals is convenient and cost-effective, it is vital to respect

copyright laws and intellectual property rights. Platforms offering free downloads often operate within legal boundaries, ensuring that the materials they provide are either in the public domain or authorized for distribution. By adhering to copyright laws, users can enjoy the benefits of free access to knowledge while supporting the authors and publishers who make these resources available. In conclusion, the availability of Tutorial Manual For Piping free PDF books and manuals for download has revolutionized the way we access and consume knowledge. With just a few clicks, individuals can explore a vast collection of resources across different disciplines, all free of charge. This accessibility empowers individuals to become lifelong learners, contributing to personal growth, professional development, and the advancement of society as a whole. So why not unlock a world of knowledge today? Start exploring the vast sea of free PDF books and manuals waiting to be discovered right at your fingertips.

FAQs About Tutorial Manual For Piping Books

1. Where can I buy Tutorial Manual For Piping books? Bookstores: Physical bookstores like Barnes & Noble, Waterstones, and independent local stores. Online Retailers: Amazon, Book Depository, and various online bookstores offer a wide range of books in physical and digital formats.
2. What are the different book formats available? Hardcover: Sturdy and durable, usually more expensive. Paperback: Cheaper, lighter, and more portable than hardcovers. E-books: Digital books available for e-readers like Kindle or software like Apple Books, Kindle, and Google Play Books.
3. How do I choose a Tutorial Manual For Piping book to read? Genres: Consider the genre you enjoy (fiction, non-fiction, mystery, sci-fi, etc.). Recommendations: Ask friends, join book clubs, or explore online reviews and recommendations. Author: If you like a particular author, you might enjoy more of their work.
4. How do I take care of Tutorial Manual For Piping books? Storage: Keep them away from direct sunlight and in a dry environment. Handling: Avoid folding pages, use bookmarks, and handle them with clean hands. Cleaning: Gently dust the covers and pages occasionally.
5. Can I borrow books without buying them? Public Libraries: Local libraries offer a wide range of books for borrowing. Book Swaps: Community book exchanges or online platforms where people exchange books.
6. How can I track my reading progress or manage my book collection? Book Tracking Apps: Goodreads, LibraryThing, and Book Catalogue are popular apps for tracking your reading progress and managing book collections. Spreadsheets: You can create your own spreadsheet to track books read, ratings, and other details.

7. What are Tutorial Manual For Piping audiobooks, and where can I find them? Audiobooks: Audio recordings of books, perfect for listening while commuting or multitasking. Platforms: Audible, LibriVox, and Google Play Books offer a wide selection of audiobooks.
8. How do I support authors or the book industry? Buy Books: Purchase books from authors or independent bookstores. Reviews: Leave reviews on platforms like Goodreads or Amazon. Promotion: Share your favorite books on social media or recommend them to friends.
9. Are there book clubs or reading communities I can join? Local Clubs: Check for local book clubs in libraries or community centers. Online Communities: Platforms like Goodreads have virtual book clubs and discussion groups.
10. Can I read Tutorial Manual For Piping books for free? Public Domain Books: Many classic books are available for free as they're in the public domain. Free E-books: Some websites offer free e-books legally, like Project Gutenberg or Open Library.

Find Tutorial Manual For Piping :

[cybersecurity strategies for entrepreneurs 19-1545](#) [cybersecurity tips for creators 19-1052](#) [mobile app ideas ideas for creators 19-1572](#) [mobile cybersecurity best practices USA 19-2639](#) [cybersecurity best practices growth ideas USA 19-1700](#) [YouTube growth ideas for entrepreneurs 19-1832](#) [examples USA 19-1607](#) [business automation examples for creators 19-879](#) [States 19-615](#) [wearable technology step by step for entrepreneurs 19-1394](#) [entrepreneurs 19-1146](#) [cloud computing case study for entrepreneurs small business 19-1401](#) [remote work software USA 19-948](#) [remote work blueprint America 19-2866](#) [remote jobs blueprint United States 19-1372](#) [explained for small business 19-1696](#) [cybersecurity explained for marketing guide for entrepreneurs 19-1749](#) [content marketing guide for business 19-2266](#) [mental wellness ideas for startups 19-2312](#) [mental remote work step by step United States 19-1169](#) [remote work step by step coding for beginners best practices USA 19-1812](#) [coding for beginners for small business 19-493](#) [cloud computing comparison America 19-155](#)

Tutorial Manual For Piping :

[savitha bhabhi velamma episode free online stories](#) - Jan 09 2023

web velamma stories velamma is an new indian cartoon character and has earned a recognition as india s top star stories the character named velamma is depicted as an attractive promiscuous lady engages in sexual adventures the velamma is commonly attached to first of indian hug cartoon lady

velamma comics indian comics porn velammacomics vip - Jan 29 2022

web velamma is a sister comics of the most famous savita bhabhi previously on kirtu com you can find these indian porn comics series on the website veena velamma and velamma dreams episodes can be read in english hindi and tamil don t forget to check all the free episodes

[indian adult comics telegram](#) - May 13 2023

web indian adult comics pinned quick links velamma comics ep 01 ep 101 ep 102 ep 110 velamma tamil ep 01 ep 05 savitha bhabhi comics ep 01 ep 99 ep 100 ep 111 to submit your comics or for promotion contact admin rlxtropy indian adult comics hey guys there s lot of

velamma comics free velamma telegram - Jul 15 2023

web velamma comics download savita bhabhi comics savitabhabhi comics 2











indian adult comics - Jun 02 2022

web dec 9 2022 tags indian adult comics velammavelamma episode 04 savita bhabhi all episodes in hindi episode 04 online episode 04 velamma all episodes in hindi velamma episode 04 chapter high quality sub indo velamma sexy adult indian comics free december 09 2022 anyverse

velamma episode velamma siterip eng directory listing archive org - Aug 16 2023

web may 1 2021 velamma episode 35 the accident pdf 01 may 2021 17 32 5 8m velamma episode 36 savita bhabhi and velamma in the same comic pdf 01 may 2021 17 31 6 2m velamma episode 38 finding a new mattress pdf 01 may 2021 17 32 6 1m velamma episode 39 when it comes to this sexy poker game vela is all

velamma in hindi all episode  **fck comics** - Aug 04 2022

web velamma all comics in hindi and savita bhabhi comics also         fck velamma velammadreams savitabhabhi veena velamma in hindi all episode    fck ep11 gplinks co spmriuh ep12 gplinks co osho ep13

savitha velamma story pdf download apeejay education society - Oct 06 2022

web free download savitha velamma story pdf or read savitha velamma story pdf on the most popular online pdf lab only register an account to downloadsavitha velamma story pdf online pdf related to savitha velamma story get access savitha

velamma storypdf and download savitha velamma story pdf for free

velamma sabita bhabi comics natore facebook - Dec 08 2022

web velamma sabita bhabi comics natore 5 980 likes 1 talking about this velamma and savita bhabi

velamma episode 103 savitahd net archive org - Feb 10 2023

web apr 30 2020 episode 103 savitahd velamma velamma comics velamma episode 103 velammacomics com collection
opensource language english indian comics lovers here in this velamma episode 103 you are going to check how the aunty is
ready to do the lesbian with her hot friend

hindi vellamma comics all episodes download comics ka adda - Apr 12 2023

web hindi savita bhabhi comics all episodes download hindi vellamma comics all episodes download english savita bhabhi
comics all episodes download english vellamma comics all episodes download random posts 4 random grid posts footer menu
widget about us contact us telegram

velamma comics episode 125 self defense a new technique - Mar 11 2023

web jun 6 2022 episode description velamma is mugged in broad daylight as a thief tries to snatch her new handbag luckily
a young female martial arts student happens to be nearby and comes to the rescue sending the thief away with a few bruises
and without the handbag but the attempted robbery convinces velamma to take a self defense class

savita bhabi free download borrow and streaming internet - Feb 27 2022

web may 28 2022 savita bhabhi is the first indian porn comics star who is popular since 2009 she keeps you turned on while
she enjoys every moment of her sexual adventures

velamma english episode all episodes pdf course hero - Nov 07 2022

web velamma all episodes free online images 3rboil net file type pdf 2014 05 velamma full story online read english velamma
comic episode 1 the savita bhabhi 21 pdf joystickaddicts com dias pdf episode story download 21 pdf pdf type pdf only 2 pdf
pdf no 84 bangla english velamma hq velamma

savitabhabhi or velamma all episode free apkpure com - Mar 31 2022

web feb 2 2018 savitabhabhi or velamma all episode free 1 0 by job seeker feb 2 2018 download apk how to install xapk apk
file follow use apkpure app get savitabhabhi or velamma all episode free old version apk for android download

📄 📄 📄 📄 📄 📄 📄 velamma sinhala - Sep 05 2022

web dec 28 2020 home comics 📄 📄 📄 📄 📄 📄 📄 velamma sinhala ceylon topic december 28 2020 📄 📄 📄 📄 📄 📄 📄

velamma savitha bhabhi comics tamil family facebook - May 01 2022

web anyone can see who s in the group and what they post

velamma episode velamma siterip eng free download - Jun 14 2023

web may 1 2021 velamma episode 36 savita bhabhi and velamma in the same comic pdf download

velamma savita bhabhi all episodes pdf files youtube - Jul 03 2022

web sep 8 2023 how to download velamma pdf full episodes along with savita bhabhi pdf s telegramt me savita bhabhi

velamma episode 88 playing the game kirtu comics - Dec 28 2021

web nov 28 2018 read velamma porn comics velamma episode 88 playing the game as in the previous episode you know that how the velamma does the rare interview with the advocate here velamma gets the new opportunity that she is going to get a more good job in the company and to meet with the rich corporate donors

how teachers and students use our the new york times - May 01 2023

web march 25 2021 a few weeks ago we asked how you were using our growing collection of winning student editorials 100 of which are featured in a new book we were delighted when both teachers

opinion editorial op ed template champion provider - Mar 19 2022

web sep 28 2017 opinion editorial op ed template the following template is an example of how to write your own op ed supporting public health efforts the template is divided into two sections the first section provides guidance and notes on the structure when crafting an op ed while the second section provides an example of op ed written

how to write an editorial examples and samples write my - Apr 19 2022

web with our simple steps you can find out how to write good editorial on your own step 1 first of all it is necessary to pick a topical issue in order to do your editorial in the best manner you have to pick the issue which is on the public mind in order to find the most interesting daily topics you can consult surveys or broadcasting step 2

how to write an editorial 7 easy steps examples guide - Sep 05 2023

web editorial examples templates as you write your own editorial study the following example templates stolen from real editorials you can use these templates as sentence starters to inspire you to write your own completely original sentences phrases for the beginning it s been two weeks since look no further than

the best editorial example to inspire your writing - Jul 23 2022

web here are 7 tips for high school students to write editorial examples select a compelling topic choose a subject that is relevant and important to you and your fellow high school students such as school policies social issues or current events

quick guide to writing an editorial for students college writers - Feb 27 2023

web when the outline is ready start to write filling every section of your paper with claims and pieces of evidence that support them if you prepare for the writing process properly you won t have any problems creating a well structured piece of writing 5 read your work read your paper aloud before submitting it

student opinion the new york times - Nov 26 2022

web student opinion daily questions inspired by times content from across sections join the conversation

sample editorials readwritethink - Jul 03 2023

web sample editorials statement they heard the bison s footsteps moving toward them and started to run but the bison caught the mother on the right side lifted her up and tossed her with its head she suffered only minor injuries other selfie related incidents involved a

free editable newspaper templates flipsnack - Aug 24 2022

web we have both university newspaper templates and student newspaper templates pick up your favorite perhaps you don t have to write about schools and universities but simply usual newspaper articles don t worry flipsnack offers you plenty of classic newspaper templates it s so easy to create your newspaper online with flipsnack

130 new prompts for argumentative writing the new york times - Mar 31 2023

web feb 12 2020 in 2017 we compiled a list of 401 argumentative writing prompts all drawn from our daily student opinion column now we re rounding up 130 more we ve published since then available here

[here s what we think editorials and opinion articles](#) - Dec 28 2022

web write an editorial have students outline or write an editorial first have students brainstorm important issues in their school or community write the ideas on a board have students vote to narrow the list to one issue

how to write an editorial steps and example examples of editorial - Aug 04 2023

web sep 14 2021 examples of editorial articles for students an editorial is a newspaper article that presents the author s public with an issue and proposes a solution learn how to write in editorial with this guide

expressing opinions with letters to the editor - Sep 24 2022

web apr 23 2021 use this lesson to prepare your students to submit letters to the times s high school letters to the editor competition the deadline to enter the 2022 contest is monday april 25 at 10 a m

free editorial template download in word google docs pdf - Jun 21 2022

web editorial make your editorials look elegant with our downloadable templates available online on template net for free we have tons of editorial designs for different use cases such as polaris editorial lookbooks youth editorial lookbook templates editorial fashion lookbooks and many more

[12 best editorial writing topics with examples 2023 become](#) - Feb 15 2022

web sep 14 2023 editorial content writing aims to inform or educate readers discover relevant editorial writing topics you can use plus examples to help you in writing editorials let writers share their point of view on different topics

how to write an editorial 6 steps for writing an editorial - Jan 29 2023

web nov 6 2023 writing an editorial is a great way to share your point of view beyond your existing network of family and

friends some newspapers welcome guest editorial pieces or letters to the editor but learning how to write an editorial effectively is essential to getting your work published

editorial topics for college students 143 good editorial ideas for - May 21 2022

web 15 sep fri written by yourdissertation reading time 7 min viewed 8 906 get your customized and 100 plagiarism free paper on any subject done on your first order learn more wrong choosing an editorial topic is a lot of fun need some proof well take a look at the ideas below

how to write an editorial steps and example 5staressays - Oct 26 2022

web sep 14 2021 when assigned to write an editorial piece you must understand the characteristics of an editorial that appeal to the reader learn how to write an editorial with this complete guide also find below some editorial topics and examples that may assist you when you begin writing your editorial

how to write an editorial essay perfect guide for students - Oct 06 2023

web learn everything there is to know about an editorial essay and the tips and tricks on how to write an evidence based one

how to write an editorial easy guide with example essay - Jun 02 2023

web dec 23 2019 an editorial is an article that presents an opinion of a group like a writer editorial writing is quite similar to research paper writing editorials are fun and exciting to write once you get all the required research material and understand the essential steps to succeed in this type of writing

russia e cina nel mondo globale due potenze fra dinamiche - May 19 2023

web russia e cina nel mondo globale due potenze fra dinamiche interne e internazionali 8843092839 9788843092833 russia e cina sono le due grandi potenze emergenti del

russia e cina nel mondo globale due potenze fra dinamiche - Aug 22 2023

web russia e cina sono le due grandi potenze emergenti del xxi secolo gelose delle proprie tradizioni e peculiarità esse tuttavia manifestano proiezioni esterne e politiche interne

russia e cina nel mondo globale due potenze fra dinamiche - Sep 11 2022

web insideover it russia e cina nel mondo globale due potenze russia e cina ostacolano gli stati uniti nel loro piano di russia e cina nel mondo globale due potenze fra

russia e cina nel mondo globale due potenze fra d - Apr 06 2022

web we present russia e cina nel mondo globale due potenze fra d and numerous books collections from fictions to scientific research in any way in the midst of them is this

russia e cina nel mondo globale due potenze fra dinamiche - Sep 30 2021

web putin russia e cina nel mondo globale due potenze fra dinamiche russia e cina alla conquista dell artico grazie al russia e

cina nel mondo globale due potenze fra

russia e cina nel mondo globale due potenze fra dinamiche - Jul 21 2023

web due potenze fra dinamiche interne e internazionali russia e cina sono le due grandi potenze emergenti del xxi secolo

gelose delle proprie tradizioni e peculiarità esse

cina e russia alla conquista dell africa e gli usa rincorrono - Oct 12 2022

web jul 24 2021 ansa panorama news cina e russia alla conquista dell africa e gli usa rincorrono dal mondo 24 luglio 2021

cina e russia alla conquista dell africa e gli usa

russia e cina nel mondo globale archiviostorico info - Feb 16 2023

web il libro russia e cina sono le due grandi potenze emergenti del xxi secolo gelose delle proprie tradizioni e peculiarità esse

tuttavia manifestano proiezioni esterne e

russia e cina nel mondo globale due potenze fra d pdf copy - Mar 05 2022

web agli attacchi della più grande potenza mondiale e dei suoi alleati un piccolo messaggio in bottiglia rivolto ai movimenti

popolari dei paesi capitalisti paralizzati da una propaganda

russia e cina nel mondo globale due potenze fra dinamiche - May 07 2022

web jun 16 2023 russia e cina nel mondo globale due potenze fra dinamiche interne e internazionali by s bianchini a fiori

una coalizione tra russia e cina sarebbe un incubo

russia e cina nel mondo globale due potenze fra d pdf - Aug 10 2022

web mar 5 2023 russia e cina nel mondo globale due potenze fra d below anticipare il futuro alberto de toni 2015 05 28t00

00 00 02 00 il mondo cambia come i disegni in

russia e cina nel mondo globale due potenze fra dinamiche - Jun 20 2023

web descrizione russia e cina sono le due grandi potenze emergenti del xxi secolo gelose delle proprie tradizioni e peculiarità

esse tuttavia manifestano proiezioni esterne e

russia e cina nel mondo globale due potenze fra d - Nov 01 2021

web mar 19 2023 russia e cina nel mondo globale due potenze fra d 2 16 downloaded from uniport edu ng on march 19

2023 by guest cosmopolita e globale dell ascesa

russia cina un patto per dominare la scena mondiale globalist it - Dec 14 2022

web feb 5 2022 patto strategico il presidente cinese xi jinping e il presidente russo vladimir putin hanno firmato ieri durante

il loro incontro una dichiarazione congiunta per

russia e cina nel mondo globale due potenze fra dinamiche - Jun 08 2022

web russia e cina nel mondo globale due potenze fra dinamiche interne e internazionali di in offerta a prezzi imbattibili su

mondadori store la cooperazione tra russia e cina l

russia e cina nel mondo globale due potenze fra dinamiche - Mar 17 2023

web acquista russia e cina nel mondo globale due potenze fra dinamiche interne e internazionali su libreria universitaria
spedizione gratuita sopra i 25 euro su libreria

russia e cina nel mondo globale due potenze fra d 2023 - Jan 15 2023

web russia e cina nel mondo globale due potenze fra d what you in the same way as to read la fine delle egemonie

associazione dialexis 2014 05 05 brics una nuova

russia e cina nel mondo globale due potenze fra d copy - Jan 03 2022

web aug 4 2023 getting the books russia e cina nel mondo globale due potenze fra d now is not type of challenging means
you could not on your own going later ebook store or

russia e cina nel mondo globale due potenze fra d - Jul 09 2022

web jul 3 2023 russia e cina nel mondo globale due potenze fra d 2 15 downloaded from uniport edu ng on july 3 2023 by
guest che come pochi altri incrocia in modo sistemico

russia e cina nel mondo globale due potenze fra d kelliemay - Dec 02 2021

web nov 17 2022 russia e cina nel mondo globale due potenze fra d 2 8 downloaded from kelliemay com on november 17
2022 by guest condizioni di precariet una lotta

russia e cina nel mondo globale due potenze fra d full pdf - Apr 18 2023

web russia e cina nel mondo globale due potenze fra d lo stato e la politica quanto contano nel mondo globale di oggi jan 21
2022 gramsci globale may 13 2021

russia e cina nel mondo globale due potenze fra d copy - Feb 04 2022

web jun 7 2023 russia e cina nel mondo globale due potenze fra d 2 15 downloaded from uniport edu ng on june 7 2023 by
guest china offers a thorough analysis of the

carocci it - Nov 13 2022

web we would like to show you a description here but the site won t allow us