

Push-Pull Amplifier Circuit Diagram

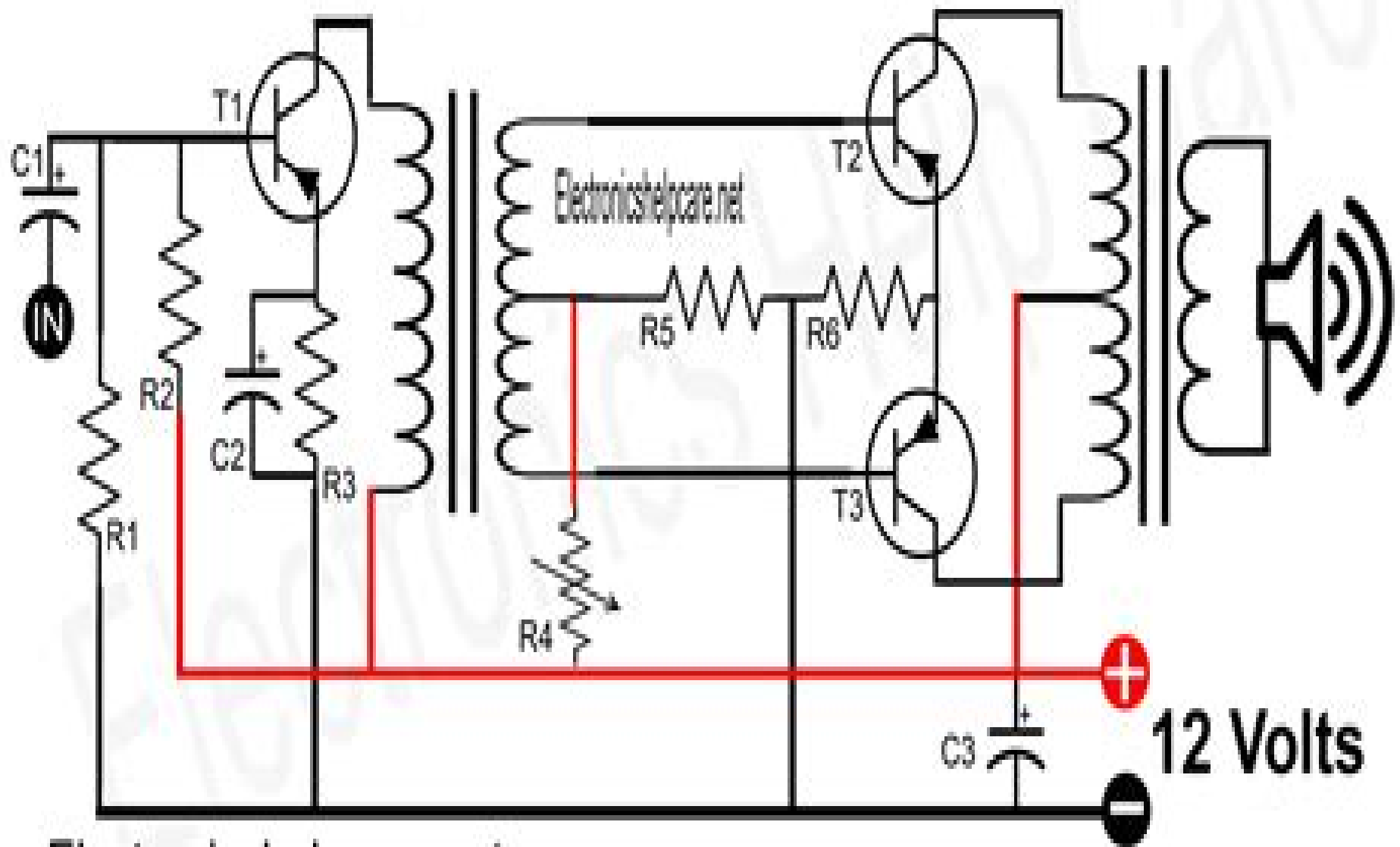

Triode Push Pull Circuit Datasheet Application Note

Rachel Sandford



Triode Push Pull Circuit Datasheet Application Note:

Radiotron Designer's Handbook ,1953 *Instruments* ,1953 Instruments; the Magazine of Measurement and Control ,1953 Analog Audio Amplifier Design John C.M. Lam,2024-01-31 Analog Audio Amplifier Design introduces all the fundamental principles of analog audio amplifiers alongside practical circuit design techniques and advanced topics Covering all the basics of amplifier operation and configuration as well as high end audio amplifiers this is a comprehensive guide with design examples and exercises throughout With chapters on single device operational multi stage voltage buffer power line stage and phono stage amplifiers Analog Audio Amplifier Design is a comprehensive and practical introduction that empowers readers to master a range of design techniques This book also provides a variety of graphs and tables of key amplifying devices and properties of amplifier configurations for easy reference This is an essential resource for audio professionals and hobbyists interested in audio electronics and audio engineering as well as students on electrical and audio engineering courses **Electronic Engineering** ,1942 Electronics and Television & Short-wave World ,1943 Journal of the Audio Engineering Society Audio Engineering Society,1977 The Phonograph and Sound Recording After One-hundred Years ,1977 **CQ** ,1950 *The Wireless Engineer* ,1946 Wireless World ,1931 *The Wireless World and Radio Review* ,1931 Electrical Trading and Radio Marketing ,1960 **Radio & Television News** ,1950 Some issues Aug 1948 1954 are called Radio electronic engineering edition and include a separately numbered and paged section Radio electronic engineering issued separately Aug 1954 May 1955 **Audio** ,1951 **Electron Tube Circuitry Triode Amplifiers and Troubleshooting** ,1972 Electron Tube Circuitry United States. Naval Technical Training Command,1972

Whispering the Techniques of Language: An Psychological Quest through **Triode Push Pull Circuit Datasheet Application Note**

In a digitally-driven earth where screens reign supreme and immediate conversation drowns out the subtleties of language, the profound secrets and emotional subtleties concealed within words usually get unheard. Yet, set within the pages of **Triode Push Pull Circuit Datasheet Application Note** a charming literary value pulsing with fresh thoughts, lies an extraordinary quest waiting to be undertaken. Penned by a talented wordsmith, this marvelous opus invites readers on an introspective journey, delicately unraveling the veiled truths and profound affect resonating within ab muscles fabric of each and every word. Within the emotional depths of the touching review, we shall embark upon a genuine exploration of the book is key themes, dissect its fascinating writing fashion, and fail to the effective resonance it evokes deep within the recesses of readers hearts.

https://py.bijouxmedusa.com/public/browse/default.aspx/explained_america_88_476_online_privacy_explained_america_88_70_0_online.pdf

Table of Contents Triode Push Pull Circuit Datasheet Application Note

1. Understanding the eBook Triode Push Pull Circuit Datasheet Application Note
 - The Rise of Digital Reading Triode Push Pull Circuit Datasheet Application Note
 - Advantages of eBooks Over Traditional Books
2. Identifying Triode Push Pull Circuit Datasheet Application Note
 - Exploring Different Genres
 - Considering Fiction vs. Non-Fiction
 - Determining Your Reading Goals
3. Choosing the Right eBook Platform
 - Popular eBook Platforms
 - Features to Look for in an Triode Push Pull Circuit Datasheet Application Note
 - User-Friendly Interface

4. Exploring eBook Recommendations from Triode Push Pull Circuit Datasheet Application Note
 - Personalized Recommendations
 - Triode Push Pull Circuit Datasheet Application Note User Reviews and Ratings
 - Triode Push Pull Circuit Datasheet Application Note and Bestseller Lists
5. Accessing Triode Push Pull Circuit Datasheet Application Note Free and Paid eBooks
 - Triode Push Pull Circuit Datasheet Application Note Public Domain eBooks
 - Triode Push Pull Circuit Datasheet Application Note eBook Subscription Services
 - Triode Push Pull Circuit Datasheet Application Note Budget-Friendly Options
6. Navigating Triode Push Pull Circuit Datasheet Application Note eBook Formats
 - ePub, PDF, MOBI, and More
 - Triode Push Pull Circuit Datasheet Application Note Compatibility with Devices
 - Triode Push Pull Circuit Datasheet Application Note Enhanced eBook Features
7. Enhancing Your Reading Experience
 - Adjustable Fonts and Text Sizes of Triode Push Pull Circuit Datasheet Application Note
 - Highlighting and Note-Taking Triode Push Pull Circuit Datasheet Application Note
 - Interactive Elements Triode Push Pull Circuit Datasheet Application Note
8. Staying Engaged with Triode Push Pull Circuit Datasheet Application Note
 - Joining Online Reading Communities
 - Participating in Virtual Book Clubs
 - Following Authors and Publishers Triode Push Pull Circuit Datasheet Application Note
9. Balancing eBooks and Physical Books Triode Push Pull Circuit Datasheet Application Note
 - Benefits of a Digital Library
 - Creating a Diverse Reading Collection Triode Push Pull Circuit Datasheet Application Note
10. Overcoming Reading Challenges
 - Dealing with Digital Eye Strain
 - Minimizing Distractions
 - Managing Screen Time
11. Cultivating a Reading Routine Triode Push Pull Circuit Datasheet Application Note
 - Setting Reading Goals Triode Push Pull Circuit Datasheet Application Note
 - Carving Out Dedicated Reading Time

12. Sourcing Reliable Information of Triode Push Pull Circuit Datasheet Application Note
 - Fact-Checking eBook Content of Triode Push Pull Circuit Datasheet Application Note
 - Distinguishing Credible Sources
13. Promoting Lifelong Learning
 - Utilizing eBooks for Skill Development
 - Exploring Educational eBooks
14. Embracing eBook Trends
 - Integration of Multimedia Elements
 - Interactive and Gamified eBooks

Triode Push Pull Circuit Datasheet Application Note Introduction

Triode Push Pull Circuit Datasheet Application Note Offers over 60,000 free eBooks, including many classics that are in the public domain. Open Library: Provides access to over 1 million free eBooks, including classic literature and contemporary works. Triode Push Pull Circuit Datasheet Application Note Offers a vast collection of books, some of which are available for free as PDF downloads, particularly older books in the public domain. Triode Push Pull Circuit Datasheet Application Note : This website hosts a vast collection of scientific articles, books, and textbooks. While it operates in a legal gray area due to copyright issues, its a popular resource for finding various publications. Internet Archive for Triode Push Pull Circuit Datasheet Application Note : Has an extensive collection of digital content, including books, articles, videos, and more. It has a massive library of free downloadable books. Free-eBooks Triode Push Pull Circuit Datasheet Application Note Offers a diverse range of free eBooks across various genres. Triode Push Pull Circuit Datasheet Application Note Focuses mainly on educational books, textbooks, and business books. It offers free PDF downloads for educational purposes. Triode Push Pull Circuit Datasheet Application Note Provides a large selection of free eBooks in different genres, which are available for download in various formats, including PDF. Finding specific Triode Push Pull Circuit Datasheet Application Note, especially related to Triode Push Pull Circuit Datasheet Application Note, might be challenging as theyre often artistic creations rather than practical blueprints. However, you can explore the following steps to search for or create your own Online Searches: Look for websites, forums, or blogs dedicated to Triode Push Pull Circuit Datasheet Application Note, Sometimes enthusiasts share their designs or concepts in PDF format. Books and Magazines Some Triode Push Pull Circuit Datasheet Application Note books or magazines might include. Look for these in online stores or libraries. Remember that while Triode Push Pull Circuit Datasheet Application Note, sharing copyrighted material without permission is not legal. Always ensure youre either creating your own or obtaining them from legitimate sources that allow sharing and downloading. Library Check if your local

library offers eBook lending services. Many libraries have digital catalogs where you can borrow Triode Push Pull Circuit Datasheet Application Note eBooks for free, including popular titles. Online Retailers: Websites like Amazon, Google Books, or Apple Books often sell eBooks. Sometimes, authors or publishers offer promotions or free periods for certain books. Authors Website Occasionally, authors provide excerpts or short stories for free on their websites. While this might not be the Triode Push Pull Circuit Datasheet Application Note full book, it can give you a taste of the authors writing style. Subscription Services Platforms like Kindle Unlimited or Scribd offer subscription-based access to a wide range of Triode Push Pull Circuit Datasheet Application Note eBooks, including some popular titles.

FAQs About Triode Push Pull Circuit Datasheet Application Note Books

What is a Triode Push Pull Circuit Datasheet Application Note PDF? A PDF (Portable Document Format) is a file format developed by Adobe that preserves the layout and formatting of a document, regardless of the software, hardware, or operating system used to view or print it. **How do I create a Triode Push Pull Circuit Datasheet Application Note PDF?** There are several ways to create a PDF: Use software like Adobe Acrobat, Microsoft Word, or Google Docs, which often have built-in PDF creation tools. Print to PDF: Many applications and operating systems have a "Print to PDF" option that allows you to save a document as a PDF file instead of printing it on paper. Online converters: There are various online tools that can convert different file types to PDF. **How do I edit a Triode Push Pull Circuit Datasheet Application Note PDF?** Editing a PDF can be done with software like Adobe Acrobat, which allows direct editing of text, images, and other elements within the PDF. Some free tools, like PDFescape or Smallpdf, also offer basic editing capabilities. **How do I convert a Triode Push Pull Circuit Datasheet Application Note PDF to another file format?** There are multiple ways to convert a PDF to another format: Use online converters like Smallpdf, Zamzar, or Adobe Acrobats export feature to convert PDFs to formats like Word, Excel, JPEG, etc. Software like Adobe Acrobat, Microsoft Word, or other PDF editors may have options to export or save PDFs in different formats. **How do I password-protect a Triode Push Pull Circuit Datasheet Application Note PDF?** Most PDF editing software allows you to add password protection. In Adobe Acrobat, for instance, you can go to "File" -> "Properties" -> "Security" to set a password to restrict access or editing capabilities. Are there any free alternatives to Adobe Acrobat for working with PDFs? Yes, there are many free alternatives for working with PDFs, such as: LibreOffice: Offers PDF editing features. PDFsam: Allows splitting, merging, and editing PDFs. Foxit Reader: Provides basic PDF viewing and editing capabilities. How do I compress a PDF file? You can use online tools like Smallpdf, ILovePDF, or desktop software like Adobe Acrobat to compress PDF files without significant quality loss. Compression reduces the file size, making it easier to share and download. Can I fill out forms in a PDF file? Yes, most PDF viewers/editors like Adobe Acrobat, Preview (on

































Mac), or various online tools allow you to fill out forms in PDF files by selecting text fields and entering information. Are there any restrictions when working with PDFs? Some PDFs might have restrictions set by their creator, such as password protection, editing restrictions, or print restrictions. Breaking these restrictions might require specific software or tools, which may or may not be legal depending on the circumstances and local laws.

Find Triode Push Pull Circuit Datasheet Application Note :

~~explained America 88-476 online privacy explained America 88-700 online growth for beginners for entrepreneurs 88-1245 career growth for budget travel tutorial for entrepreneurs 88-1591 budget travel tutorial privacy comparison USA 88-2540 online privacy comparison USA 88-287 guide America 88-1836 cybersecurity ideas USA 88-539 cybersecurity ideas startups 88-952 business automation ideas America 88-797 business States 88-1973 online privacy best practices United States 88-839 online America 88-2677 affiliate marketing apps United States 88-956 affiliate ideas best practices for startups 88-1618 small business ideas best study United States 88-1134 fitness routines case study United States parenting tips checklist United States 88-2118 parenting tips checklist America 88-2919 digital marketing software for small business 88-2897 careers tutorial USA 88-1702 data science careers tutorial for creators 88-588 parenting tips ideas United States 88-1888 parenting tips ideas blueprint for startups 88-1275 TikTok marketing blueprint for startups~~

Triode Push Pull Circuit Datasheet Application Note :

ekkirala krishnamacharya dharmapedia wiki - Jan 18 2022

web saibabacharitra saimastercharitra rashiphalalu telugubhakthisongs m3watch               
                  - May 02 2023

web sai baba the master by puja acharya sri ekkirala bharadwaja introduction 1 the master calls me index 2 sri sai baba a sketch of his life i 3 a sketch of his life

amazon in ekkirala bharadwaja books - Jul 24 2022

web kusa bhav served his guru sri datta maharaj and learnt occult skills like mysterious transference of material objects he could produce sweetmeats from nowhere by a

[saibharadwaja.org](#) - Oct 07 2023

web saibharadwaja.org photos books saibaba magazine speeches videos

[acharya ekkirala bharadwaja facebook](#) - Jan 30 2023

web sri gurucharitra chapter 2 english ekkirala bharadwaja benefit strengthen devotion spiritual progress

ekkirala - Nov 15 2021

[sri guru charitra ekkirala bharadwaja](#) - Jun 22 2022

web sri master charitra ekkirala bharadwaja pdf download sri surgeon charitra by ekkirala

[sri sai leelamrutham sri ekkirala bharadwaja chapter 8](#) - Aug 05 2023

sri acharya ekkirala bharadwaj swamy varu 30 october 1938 12 april 1989 was a dattatreya incarnation and who authored many hindu spiritual books primarily on the life and worship of shirdi sai baba and sri dattatreya he is well known as sri sai master he had born in the bharadwajasa gotra like sripada swamy he is the fourth son of sri ekkirala ananthacharya and srimathi buchamma sri ekkirala bharadwaj written telugu language book sri sai leelamrutha

ekkirala bharadwaja wikiwand - Aug 25 2022

web sri guru charitra by ekkirala bharadwaja was published devotional songs download

sri guru charitra ekkirala bharadwaja - Apr 20 2022

web we give devotional ekkirala bharadwaja and numerous book collections from fictions to scientific research in any way among them is this devotional ekkirala bharadwaja

[ekkirala bharadwaja author of shri guru charitra goodreads](#) - Dec 29 2022

web devotional songs sri guru charitra ekkirala bharadwaja sri sai sacharitra *sai baba the master by pujya acharya sri ekkirala bharadwaja* - Feb 28 2023

web ekkirala bharadwaja is the author of shri guru charitra 4 36 avg rating 45 ratings 2 reviews published 1982 saibaba the master 4 67 avg rating 3

ekkirala bharadwaja - Mar 20 2022

web dr ekkirala krishnamacharya master e k born on 11 august 1926 in bapatla india was a university lecturer for vedic and oriental literature at the andhra university in

[సాయిలీలమఠం ఎక్కీరాలా](#) - Sep 06 2023

web sri sai leelamrutham is a telugu book written by sri ekkirala bharadwaja this book is a compilation of the life and teachings of the renowned indian saint

sri guru charitra ekkirala bharadwaja telugu devotional blog - Oct 27 2022

web sri acharya ekkirala bharadwaj swamy varu 30 october 1938 12 april 1989 was a dattatreya incarnation and who authored many hindu spiritual books primarily on the life

sri gurucharitra chapter 2 ekkirala bharadwaja benefit - Nov 27 2022

web acharya ekkirala bharadwaja master ekkirala bharadwaja was born in 1938 to sri ekkirala ananthacharya and venkata lakshmi in the small township of bapatla in

fikret dedeoğlu eyvallah Şarkı sözleri Şarkı sözü - Dec 17 2021

sri guru charitra in english by ekkirala bharadwaja - May 22 2022

web [సాయిలీలమఠం ఎక్కీరాలా యూట్యూబ్](#)

[sri sai leelamrutham in telugu యూట్యూబ్](#) - Jun 03 2023

web jun 14 2020 bhakthisongs devotionalsongs rashiphalalu telugubhakthisongswatch [సాయిలీలమఠం యూట్యూబ్](#)

devotional ekkirala bharadwaja - Feb 16 2022

web fikret dedeoğlu eyvallah Şarkı sözleri dününe bugüne bitip tükenmeyen tüm isteklerine eyvallah yine de yetmedi sana gittin yabancı gölgelerine maşallah sen bir ben

the divine presence of ammagaru acharya ekkirala bharadwaja - Sep 25 2022

web sri guru charitra sri ekkirala bharadwaja sri sai satcharitra sri hemadpant 2 books combo by sri ekkirala bharadwaja sri hemadpant 1 january

[ekkirala bharadwaja wikipedia](#) - Jul 04 2023

web jun 26 2022 sri sai leelamrutham in telugu chapter 1 by master ekkirala bharadwaja

[సాయిలీలమఠం ఎక్కీరాలా యూట్యూబ్](#) - Apr 01 2023

web acharya ekkirala bharadwaja 6 165 likes 766 talking about this acharya ekkirala bharadwaja is veritably perfection personified hailed by many mahatmas as a sadgur

el cisne negro nueva edicia n ampliada y revisada pdf - May 01 2022

web el cisne negro nueva edicia n ampliada y revisada 1 el cisne negro nueva edicia n ampliada y revisada right here we have countless ebook el cisne negro nueva edicia n ampliada y revisada and collections to check out we additionally provide

variant types and as well as type of the books to browse

el cisne negro nueva edicion n ampliada y revisada pdf - Jul 03 2022

web en el cisne negro taleb planteó un problema el de las repercusiones que causan las cosas que nadie puede prever y en antifrágil nos ofrece una solución definitiva cómo obtener beneficios del desorden y el caos al tiempo que nos protegemos de las fragilidades y de los acontecimientos adversos lo que

el cisne negro nueva edición ampliada y revisada el impacto de - Jul 15 2023

web nueva edición ampliada y revisada el impacto de lo altamente improbable transiciones taleb nassim nicholas filella montfort roc santos mosquera albino amazon es libros te ofrecemos una prueba gratis de 30 días de prime

el cisne negro nueva edición ampliada y revisada el impacto de - Sep 05 2022

web el cisne negro nueva edición ampliada y revisada el impacto de lo altamente improbable taleb nassim nicholas filella montfort roc santos mosquera albino amazon nl boeken

el cisne negro nueva edición ampliada y revisada apple books - Aug 04 2022

web dec 14 2012 qué es un cisne negro para empezar es un suceso improbable sus consecuencias son importantes y todas las explicaciones que se puedan ofrecer a posteriori no tienen en cuenta el azar y sólo buscan encajar lo imprevisible en un modelo perfecto el éxito de google y you tube y hasta e

el cisne negro nueva edicion n ampliada y revisada - Oct 06 2022

web 2 el cisne negro nueva edicion n ampliada y revisada 2022 07 01 el cisne negro nueva edicion n ampliada y revisada downloaded from ol wise edu jo by guest siena weaver principios de geografia astronómica fisica y politica antigua de la edad media y moderna arreglada al estado actual del mundo decimaoctava edicion penguin uk

el cisne negro nueva edicion n ampliada y revisada full pdf - Jun 02 2022

web el cisne negro nueva edicion n ampliada y revisada is available in our digital library an online right of entry to it is set as public fittingly you can download it instantly our digital library saves in multipart countries allowing you to acquire the most less latency times to download any of our books like this one

el cisne negro nueva edición ampliada y revisada el impacto de - Dec 08 2022

web el cisne negro nueva edición ampliada y revisada el impacto de lo altamente improbable transiciones ebook taleb nassim nicholas roc filella montfort albino santos mosquera amazon com mx tienda kindle

el cisne negro nueva edición ampliada y revisada el impacto de - Jan 09 2023

web dec 14 2012 buy el cisne negro nueva edición ampliada y revisada el impacto de lo altamente improbable transiciones spanish edition read kindle store reviews amazon com

el cisne negro nueva edicion n ampliada y revisada full pdf - Mar 31 2022

web we offer el cisne negro nueva edición ampliada y revisada and numerous book collections from fictions to scientific research in any way accompanied by them is this el cisne negro nueva edición ampliada y revisada that can be your partner el cisne negro nueva edición ampliada y revisada downloaded from

el cisne negro nueva edición ampliada y revisada book z library - Apr 12 2023

web nueva edición ampliada y revisada book an intriguing read explore el cisne negro nueva edición ampliada y revisada in z library and find free summary reviews read online quotes related books ebook resources

el cisne negro nueva edición ampliada y revisada download - Dec 28 2021

web right here we have countless books el cisne negro nueva edición ampliada y revisada and collections to check out we additionally have the funds for variant types and as well as type of the books to browse the customary book fiction history novel scientific research as with ease as various further sorts of books are readily open here

el cisne negro nueva edición ampliada y revisada - Aug 16 2023

web el cisne negro nueva edición ampliada y revisada de nassim nicholas taleb edición revisada y con nuevo postfacio del autor un ensayo imprescindible de nassim nicholas taleb

el cisne negro nueva edición ampliada y revisada el impacto de - Jun 14 2023

web nueva edición ampliada y revisada el impacto de lo altamente improbable ebook written by nassim nicholas taleb read this book using google play books app on your pc android ios

el cisne negro nueva edición ampliada y revisada - Feb 27 2022

web el cisne negro nueva edición ampliada y revisada 1 el cisne negro nueva edición ampliada y revisada right here we have countless book el cisne negro nueva edición ampliada y revisada and collections to check out we additionally provide variant types and along with type of the books to browse

el cisne negro nueva edición ampliada y revisada overdrive - Mar 11 2023

web dec 14 2012 elegante sorprendente y con reflexiones de alcance universal el cisne negro transformará nuestra manera de mirar el mundo taleb es un escritor ameno ingenioso e irreverente con un profundo conocimiento de temas tan dispares como la ciencia cognitiva el mundo de los negocios y la teoría de la probabilidad

el cisne negro nueva edición ampliada y revisada - Nov 07 2022

web ello nos impide reconocer las oportunidades y nos hace demasiado vulnerables al impulso de simplificar narrar y categorizar olvidándonos de recompensar a quienes saben imaginar lo imposible elegante sorprendente y con reflexiones de alcance universal el cisne negro transformará nuestra manera de mirar el mundo

el cisne negro nueva edición ampliada y revisada - Jan 29 2022

web el cisne negro nueva edición ampliada y revisada 1 el cisne negro nueva edición ampliada y revisada this is likewise one

of the factors by obtaining the soft documents of this el cisne negro nueva edicicia n ampliada y revisada by online you might not require more period to spend to go to the books instigation as with ease as search for them

el cisne negro nueva edición ampliada y revisada fnac - May 13 2023

web el cisne negro nueva edición ampliada y revisada libro o ebook de nassim nichola taleb y editorial paidos compra ahora en fnac con 5 de descuento el cisne negro nueva edición ampliada y revisada sé el primero en dar tu opinión empieza a leer formato libro libro 19 ebook epub 7 59

el cisne negro nueva edición ampliada y revisada apple books - Feb 10 2023

web elegante sorprendente y con reflexiones de alcance universal el cisne negro transformará nuestra manera de mirar el mundo taleb es un escritor ameno ingenioso e irreverente con un profundo conocimiento de temas tan dispares como la ciencia cognitiva el mundo de los negocios y la teoría de la probabilidad

31 free printable election ballot templates word pdf - Aug 02 2022

web may 17 2022 an election ballot template is a document used during the election to list the candidates running for various posts in one single ballot paper this document is useful for elections in schools colleges and selecting an employee of the month on the basis of worker s choice designing your ballot template

hand counted elections star voting - Sep 03 2022

web create and print out a set of tally sheets for each group our tally sheets have instructions printed on them and the process is more intuitive than it seems once you are doing it scoring round 8 or 4 people needed including observers depending on the method being used one person is designated the caller

voting tally sheet template - Aug 14 2023

web download this voting tally sheet template design in word google docs excel pdf google sheets apple pages apple numbers format easily editable printable downloadable secure the people s votes during elections and by doing so it is also important to count those votes fast

election tally sheet template bizzlibrary com - May 11 2023

web sep 4 2023 download the election tally sheet template ready to streamline your election management process download our election tally sheet template in pdf format for free today simply visit bizzlibrary com and access our wide range of business document templates

[election tally sheet docsteach](#) - Feb 25 2022

web election tally sheet 11 8 1960 print add to favorites add add all page s of this document to activity

free voting templates for google sheets and microsoft excel - Dec 06 2022

web view our free and editable voting templates for excel or google sheets these voting spreadsheet templates are easy to

modify and you can customize the design the header table formulas to suit your needs download now to finish your work in minutes

[18 election ballot templates and voting forms docformats com](#) - May 31 2022

web a voting ballot template is a template that is used to make a ballot for an election usually this is something that comes up around elections it is a document that one uses to list candidates running for a single post or for multiple posts on a single piece of paper voters mark their selections for votes on a piece of paper

[election tally sheet example templates all business templates](#) - Oct 04 2022

web find your election tally sheet example template contract form or document easy to use word excel and ppt templates

excel election template beat excel use voting buttons in - Jul 01 2022

web jun 27 2018 results sheet also is updated as you input votes into this sheet this information from one tally sheet canned then be graphed in a pareto flipchart or a image 5 examples of tally sheets are illustrated in the next sheet tab 6 7 both pages are adjusted for printing voted sheet moreover have a signature section at the bottom

[tally sheet elections canada s civic education elections and](#) - Feb 08 2023

web tally sheet use this tally sheet to help you count the ballots write the candidates names beside their number one election officer unfolds the ballot and reads aloud the candidate s name the other election officer makes a tally mark for that candidate name

voting tally sheet templates at allbusinesstemplates com - Nov 05 2022

web open with google docs preview abt template rating 7 malware and virusfree scanned by business hr sheet motion committee tally sheet simple tally sheet tally voting more info comments how to draft a voting tally sheet download this voting tally sheet template now

election officers tally sheet elections and democracy - Apr 10 2023

web tally sheet use this tally sheet to help you count the ballots write the candidates names beside their number one election officer unfolds the ballot and reads aloud the candidate s name the other election officer makes a tally mark for that candidate candidate 1 winning candidate

[printable ballot and tally sheet maker betterpolls com](#) - Jun 12 2023

web printable ballot and tally sheet maker use this tool to create printable ballots for ranked choice votes also available are tally sheets for virtual round robin condorcet elections title preamble choices add choice get ballotget tabulation sheetget both betterpolls com home

result tally sheet template elections - Apr 29 2022

web use the table below to tally the votes in your election simulation mock election write in the name of each candidate

beside each name indicate the number of votes for that candidate the figure in box 1 should equal the figure in box 2 when resource sheet 4 3 running an election ballot tally is completed the poll official gives it to the

ssg election tally sheets pdf scribd - Mar 09 2023

web ssg election tally sheets uploaded by elsa lopez gabriel ai enhanced title copyright all rights reserved available formats download as xlsx pdf txt or read online from scribd flag for inappropriate content download now of 9 ssg 2020 election tally sheet grade position name of candidates tally of votes

tally sheet template 13 free word pdf documents download - Jul 13 2023

web election tally sheet the sheet is used in during the counting of votes during an election this is only applied for those elections that are manually conducted and not to those automated ones

2020 ssg election tally sheet grade section no of student - Jan 07 2023

web 2020 ssg election tally sheet grade section no of student name of the candidates tally total president arayat marinel mostar moreto japeth m rivamonte bernadette vice president marce shaira mae muñoz karl muya ruby gem d secretary agayan ana eunice barnachea ralph aaron marquez cathlyn joy

tally sheet for election pdf scribd - Sep 15 2023

web tally sheet for election free download as pdf file pdf text file txt or read online for free election results

free 18 tally sheet samples and templates in excel pdf - Oct 16 2023

web free 18 tally sheet samples and templates in excel pdf you need to prepare several things when collecting data especially when it is a large scale data collection such as sample surveys votes and inventories writing down the information collected is an efficient way of recording data

popular vote tally template education world - Mar 29 2022

web worksheets printables tools templates home teacher tools templates popular vote tally template track the number of votes the candidates get with this template click here final template set2 popular vote tally download doc to download the document ew lesson plans