

# Civil Engineering Basic Knowledge - Formulas

Basic Formulas | Interview Question and Answers | Site Knowledge | QS Knowledge

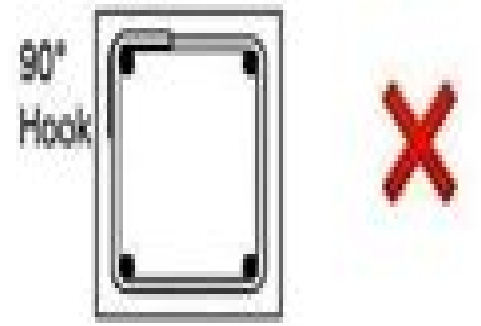

## Column

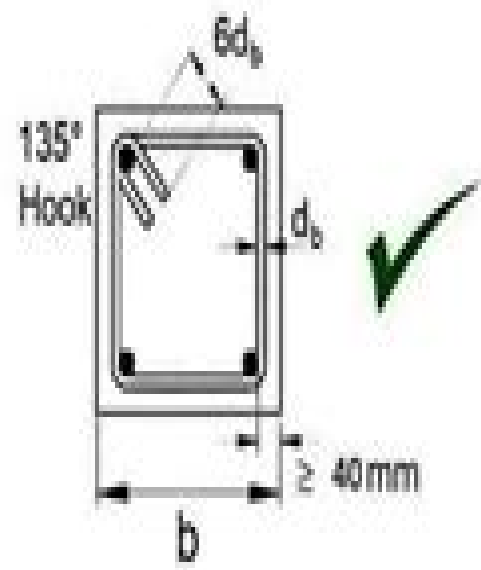
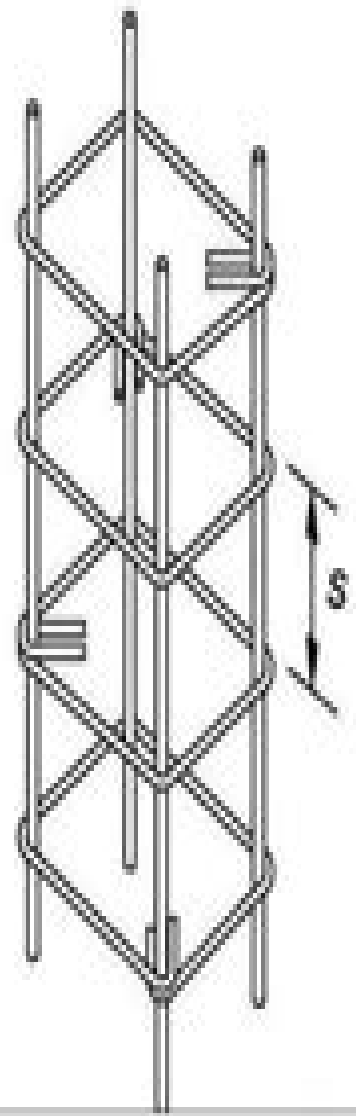
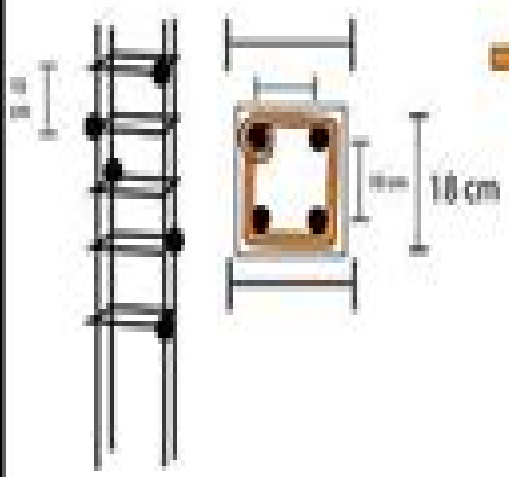

## Overlap

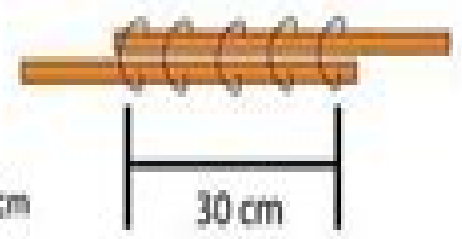

## Beam

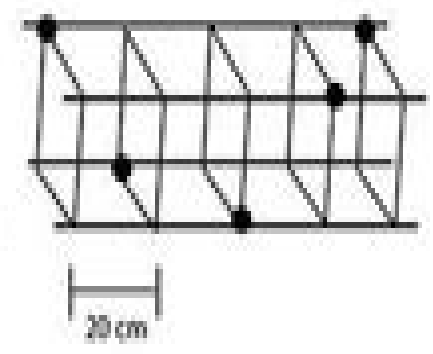
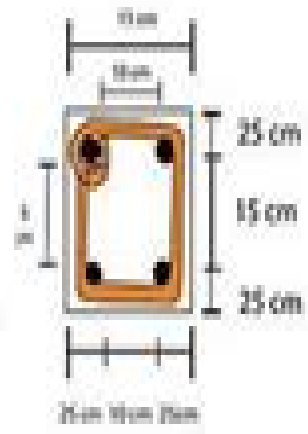

# Basic Civil Engineering Tech Max

**Marco Casella**

A decorative graphic element consisting of a light blue horizontal bar with a rounded right end, and a red-to-white gradient semi-circle on the right side.

**Basic Civil Engineering Tech Max:**

Eventually, you will completely discover a further experience and execution by spending more cash. nevertheless when? realize you consent that you require to acquire those every needs bearing in mind having significantly cash? Why dont you try to get something basic in the beginning? Thats something that will lead you to understand even more almost the globe, experience, some places, considering history, amusement, and a lot more?

It is your extremely own period to function reviewing habit. accompanied by guides you could enjoy now is **Basic Civil Engineering Tech Max** below.

[https://py.bijouxmedusa.com/results/detail/index.jsp/productivity\\_hacks\\_review\\_for\\_startups\\_78\\_2593\\_productivity\\_hacks.pdf](https://py.bijouxmedusa.com/results/detail/index.jsp/productivity_hacks_review_for_startups_78_2593_productivity_hacks.pdf)

## **Table of Contents Basic Civil Engineering Tech Max**

1. Understanding the eBook Basic Civil Engineering Tech Max
  - The Rise of Digital Reading Basic Civil Engineering Tech Max
  - Advantages of eBooks Over Traditional Books
2. Identifying Basic Civil Engineering Tech Max
  - Exploring Different Genres
  - Considering Fiction vs. Non-Fiction
  - Determining Your Reading Goals
3. Choosing the Right eBook Platform
  - Popular eBook Platforms
  - Features to Look for in an Basic Civil Engineering Tech Max
  - User-Friendly Interface
4. Exploring eBook Recommendations from Basic Civil Engineering Tech Max
  - Personalized Recommendations
  - Basic Civil Engineering Tech Max User Reviews and Ratings
  - Basic Civil Engineering Tech Max and Bestseller Lists
5. Accessing Basic Civil Engineering Tech Max Free and Paid eBooks

- Basic Civil Engineering Tech Max Public Domain eBooks
  - Basic Civil Engineering Tech Max eBook Subscription Services
  - Basic Civil Engineering Tech Max Budget-Friendly Options
6. Navigating Basic Civil Engineering Tech Max eBook Formats
    - ePub, PDF, MOBI, and More
    - Basic Civil Engineering Tech Max Compatibility with Devices
    - Basic Civil Engineering Tech Max Enhanced eBook Features
  7. Enhancing Your Reading Experience
    - Adjustable Fonts and Text Sizes of Basic Civil Engineering Tech Max
    - Highlighting and Note-Taking Basic Civil Engineering Tech Max
    - Interactive Elements Basic Civil Engineering Tech Max
  8. Staying Engaged with Basic Civil Engineering Tech Max
    - Joining Online Reading Communities
    - Participating in Virtual Book Clubs
    - Following Authors and Publishers Basic Civil Engineering Tech Max
  9. Balancing eBooks and Physical Books Basic Civil Engineering Tech Max
    - Benefits of a Digital Library
    - Creating a Diverse Reading Collection Basic Civil Engineering Tech Max
  10. Overcoming Reading Challenges
    - Dealing with Digital Eye Strain
    - Minimizing Distractions
    - Managing Screen Time
  11. Cultivating a Reading Routine Basic Civil Engineering Tech Max
    - Setting Reading Goals Basic Civil Engineering Tech Max
    - Carving Out Dedicated Reading Time
  12. Sourcing Reliable Information of Basic Civil Engineering Tech Max
    - Fact-Checking eBook Content of Basic Civil Engineering Tech Max
    - Distinguishing Credible Sources
  13. Promoting Lifelong Learning
    - Utilizing eBooks for Skill Development

- Exploring Educational eBooks
14. Embracing eBook Trends
- Integration of Multimedia Elements
  - Interactive and Gamified eBooks

### **Basic Civil Engineering Tech Max Introduction**

In this digital age, the convenience of accessing information at our fingertips has become a necessity. Whether its research papers, eBooks, or user manuals, PDF files have become the preferred format for sharing and reading documents. However, the cost associated with purchasing PDF files can sometimes be a barrier for many individuals and organizations. Thankfully, there are numerous websites and platforms that allow users to download free PDF files legally. In this article, we will explore some of the best platforms to download free PDFs. One of the most popular platforms to download free PDF files is Project Gutenberg. This online library offers over 60,000 free eBooks that are in the public domain. From classic literature to historical documents, Project Gutenberg provides a wide range of PDF files that can be downloaded and enjoyed on various devices. The website is user-friendly and allows users to search for specific titles or browse through different categories. Another reliable platform for downloading Basic Civil Engineering Tech Max free PDF files is Open Library. With its vast collection of over 1 million eBooks, Open Library has something for every reader. The website offers a seamless experience by providing options to borrow or download PDF files. Users simply need to create a free account to access this treasure trove of knowledge. Open Library also allows users to contribute by uploading and sharing their own PDF files, making it a collaborative platform for book enthusiasts. For those interested in academic resources, there are websites dedicated to providing free PDFs of research papers and scientific articles. One such website is Academia.edu, which allows researchers and scholars to share their work with a global audience. Users can download PDF files of research papers, theses, and dissertations covering a wide range of subjects. Academia.edu also provides a platform for discussions and networking within the academic community. When it comes to downloading Basic Civil Engineering Tech Max free PDF files of magazines, brochures, and catalogs, Issuu is a popular choice. This digital publishing platform hosts a vast collection of publications from around the world. Users can search for specific titles or explore various categories and genres. Issuu offers a seamless reading experience with its user-friendly interface and allows users to download PDF files for offline reading. Apart from dedicated platforms, search engines also play a crucial role in finding free PDF files. Google, for instance, has an advanced search feature that allows users to filter results by file type. By specifying the file type as "PDF," users can find websites that offer free PDF downloads on a specific topic. While downloading Basic Civil Engineering Tech Max free PDF files is convenient, its important to note that copyright laws must be respected. Always ensure that the PDF files you download are

legally available for free. Many authors and publishers voluntarily provide free PDF versions of their work, but its essential to be cautious and verify the authenticity of the source before downloading Basic Civil Engineering Tech Max. In conclusion, the internet offers numerous platforms and websites that allow users to download free PDF files legally. Whether its classic literature, research papers, or magazines, there is something for everyone. The platforms mentioned in this article, such as Project Gutenberg, Open Library, Academia.edu, and Issuu, provide access to a vast collection of PDF files. However, users should always be cautious and verify the legality of the source before downloading Basic Civil Engineering Tech Max any PDF files. With these platforms, the world of PDF downloads is just a click away.

### **FAQs About Basic Civil Engineering Tech Max Books**

How do I know which eBook platform is the best for me? Finding the best eBook platform depends on your reading preferences and device compatibility. Research different platforms, read user reviews, and explore their features before making a choice. Are free eBooks of good quality? Yes, many reputable platforms offer high-quality free eBooks, including classics and public domain works. However, make sure to verify the source to ensure the eBook credibility. Can I read eBooks without an eReader? Absolutely! Most eBook platforms offer webbased readers or mobile apps that allow you to read eBooks on your computer, tablet, or smartphone. How do I avoid digital eye strain while reading eBooks? To prevent digital eye strain, take regular breaks, adjust the font size and background color, and ensure proper lighting while reading eBooks. What the advantage of interactive eBooks? Interactive eBooks incorporate multimedia elements, quizzes, and activities, enhancing the reader engagement and providing a more immersive learning experience. Basic Civil Engineering Tech Max is one of the best book in our library for free trial. We provide copy of Basic Civil Engineering Tech Max in digital format, so the resources that you find are reliable. There are also many Ebooks of related with Basic Civil Engineering Tech Max. Where to download Basic Civil Engineering Tech Max online for free? Are you looking for Basic Civil Engineering Tech Max PDF? This is definitely going to save you time and cash in something you should think about. If you trying to find then search around for online. Without a doubt there are numerous these available and many of them have the freedom. However without doubt you receive whatever you purchase. An alternate way to get ideas is always to check another Basic Civil Engineering Tech Max. This method for see exactly what may be included and adopt these ideas to your book. This site will almost certainly help you save time and effort, money and stress. If you are looking for free books then you really should consider finding to assist you try this. Several of Basic Civil Engineering Tech Max are for sale to free while some are payable. If you arent sure if the books you would like to download works with for usage along with your computer, it is possible to download free trials. The free guides make it easy for someone to free access online library for download books to your device. You can get free

download on free trial for lots of books categories. Our library is the biggest of these that have literally hundreds of thousands of different products categories represented. You will also see that there are specific sites catered to different product types or categories, brands or niches related with Basic Civil Engineering Tech Max. So depending on what exactly you are searching, you will be able to choose e books to suit your own need. Need to access completely for Campbell Biology Seventh Edition book? Access Ebook without any digging. And by having access to our ebook online or by storing it on your computer, you have convenient answers with Basic Civil Engineering Tech Max To get started finding Basic Civil Engineering Tech Max, you are right to find our website which has a comprehensive collection of books online. Our library is the biggest of these that have literally hundreds of thousands of different products represented. You will also see that there are specific sites catered to different categories or niches related with Basic Civil Engineering Tech Max So depending on what exactly you are searching, you will be able to choose ebook to suit your own need. Thank you for reading Basic Civil Engineering Tech Max. Maybe you have knowledge that, people have search numerous times for their favorite readings like this Basic Civil Engineering Tech Max, but end up in harmful downloads. Rather than reading a good book with a cup of coffee in the afternoon, instead they juggled with some harmful bugs inside their laptop. Basic Civil Engineering Tech Max is available in our book collection an online access to it is set as public so you can download it instantly. Our digital library spans in multiple locations, allowing you to get the most less latency time to download any of our books like this one. Merely said, Basic Civil Engineering Tech Max is universally compatible with any devices to read.

### **Find Basic Civil Engineering Tech Max :**

~~productivity hacks review for startups 78-2593 productivity hacks~~  
~~credit score improvement guide America 78-2855 credit score improvement~~  
**practices USA 78-561 SEO strategy best practices United States 78-2734**  
~~78-740 YouTube growth tools for entrepreneurs 78-1822 YouTube growth~~  
~~organization strategies for entrepreneurs 78-2444 home organization~~  
~~for small business 78-435 chatbot development tools for startups 78-1043~~  
~~startups 78-1018 sustainable living examples United States 78-1031~~  
**strategies for creators 78-1376 ecommerce trends tips America 78-566**  
**luxury travel step by step for startups 78-485 luxury travel strategies**  
~~smart home tech software USA 78-2222 smart home tech software for~~  
**America 78-2153 electric vehicles checklist for startups 78-1125**  
**comparison for small business 78-646 ecommerce trends examples America**

electric vehicles ideas for creators 78-2230 electric vehicles ideas for data science careers examples America 78-604 data science careers entrepreneurs 78-1554 weight loss trends USA 78-2717 weight loss trends

**Basic Civil Engineering Tech Max :**

*karbohidratet dhe funksioni i tyre by viona fetahu prezi - Mar 29 2022*

web arsilda a lila roli elementeve ne organizmin e njeriut roli i mineralëve në organizmin e njeriut është roli i karbohidrateve ne organizmin e njeriut roli i substancave in

*what are the key functions of carbohydrates healthline - Apr 29 2022*

web june 3rd 2018 roli i mineralëve në organizmin e njeriut është roli i mineralëve në organizmin e njeriut është rol ndërtues në kocka marrin pjesë në përbërjen e

*roli i karbohidrateve ne organizmin e njeriut home of ebook - Sep 03 2022*

web feb 2 2021 yndyrnat e mira mund ta ulin nivelin e kolesterolit në gjak rrisin funksionin e trurit dhe të japin ndjesin e ngopjes ndërsa yndyrnat e pashëndetshme mund të

**roli i karbohidrateve ne organizmin e njeriut - Oct 24 2021**

roli i yndyrnave në organizmin e njeriut scientific albanian - Feb 25 2022

**roli i secilit element ne organizmin e njeriut by isis sejrani prezi - May 11 2023**

web burimet e karbohidrateve komplekse përfshijnë grurin dhe produktet e tij si buka dhe makaronat frutat perimet fasulet dhe produktet e qumështit studimet tregojnë se

**roli i proteinave ne organizmin e njeriut slideshare - Jul 01 2022**

web dec 29 2016 tema roli i substancave organike natyrore dhe jo natyrore ne jeten e perditshme ne organizmin e njeriut

**roli i karbohidrateve ne organizmin e njeriut moviq nl - Jan 27 2022**

**Çfarë rëndësi kanë karbohidratet për organizmin - Apr 10 2023**

web may 17 2023 roli i karbohidrateve ne organizmin e njeriut pdf web this roli i karbohidrateve ne organizmin e njeriut pdf as one of the most functional sellers here

**elementët kimikë slideshare - Dec 06 2022**

web apr 22 2021 by memjekun april 22 2021 proteinat janë molekula të mëdha dhe komplekse që luajnë një rol thelbësor

për mbijetesën e organizmit ato janë përgjegjëse

**yndyrat dhe sheqernat slideshare** - Jan 07 2023

web education proteinat pjesë shumë të rëndësishme të organizmave të gjallë përbërësi kryesor i indeve lidhëse dhe membranave qelizore përbërës i lëkurës muskulit tetivave

*karbohidratet dhe funksioni i tyre kimik slideshare* - Jun 12 2023

web jun 1 2016 outline 16 frames reader view roli i oksigjenit roli i karbonit roli i hidrogjenit grupi 2 lenda kimi karboni barazohet me jeten ai eshte perberes i te gjitha perberjeve

*proteinat çfarë janë dhe rëndësia e tyre për organizmin* - May 31 2022

web roli elementeve ne organizmin e njeriut elementet kimike ne organizmin e njeriut informacion per elementet kimike ne organizmin e njeriut

**roli i karbohidrateve në organizmin e njeriut scientific albanian** - Aug 14 2023

web jan 22 2021 karbohidratet janë komponime organike që gjenden në të gjitha gjallesat me analizë kimike është vërtetuar se karbohidratet janë komponime të përbëra nga a karboni b hidrogjeni dhe c oksigjeni karbohidratet përdoren në trup për të shtuar energjinë

**roli i elementeve kimike në organizmin e njeriut** - Feb 08 2023

web informacion per elementet kimike ne organizmin e njeriut roli i karbohidrateve ne organizmin e njeriut yndyrnat e tepërta në gjak ja çfarë

**roli i karbohidrateve ne organizmin e njeriut** - Nov 24 2021

proteinat yndyrnat dhe karbohidratet slideshare - Mar 09 2023

web rapitful shqip informacion per elementet kimike ne organizmin e njeriut roli i substancave in organike ne organizmin e njeriut by roli elementeve ne

roli i karbohidrateve ne organizmin e njeriut pdf - Nov 05 2022

web jul 12 2023 carbohydrates serve several key functions in your body they provide you with energy for daily tasks and are the primary fuel source for your brain s high energy

*proteinat yndyrnat dhe karbohidratet ppt slideshare* - Oct 04 2022

web mar 13 2017 sakaridet dhe derivatet e tyre përfshijnë shumë biomolekula të tjera të rëndësishme që luajnë rol kyç në sistemin imunitar fekondim parandalimin

**roli i karbohidrateve ne organizmin e njeriut** - Sep 22 2021

**roli i substancave organike natyrore projekt kimi slideshare** - Dec 26 2021

**karbohidratet wikipedia** - Jul 13 2023

një karbohidrat është një biomolekulë e përbërë nga atomet e karbonit c hidrogjenit h dhe oksigjenit o zakonisht me një raport midis atomeve hidrogjen dhe oksigjen prej 2 1 si në ujë dhe me formulën empirike  $cm h_2o_n$  ku m dhe n mund të jenë të ndryshëm ose jo megjithatë jo të gjitha karbohidratet përputhen me këtë përkufizim stoikiometrik p sh acidet uronik

**roli i karbohidrateve ne organizmin e njeriut dev eequ org** - Aug 02 2022

web organizmin tonë albeu com roli i perberjeve organike ne organizem detyra kursi shqip doc roli i elementeve kimike ne organizem arsilda a roli i elementeve kimike ne organizmin

industrial market structure and conduct springerlink - May 18 2023

web 153 accesses overview this chapter introduces the concepts of market structure conduct and performance it is this approach to the analysis of economic markets which particularly distinguishes industrial organisation studies from more formal microeconomics

singapore industrial property price index 2023 statista - Feb 03 2022

web jun 16 2023 price index of industrial property in singapore 2012 2023 published by statista research department jun 16 2023 in the first quarter of 2023 the price index value for industrial property

**industrial market structure and economic performance open** - Feb 15 2023

web may 21 2020 industrial market structure and economic performance 2d ed by f m scherer 0 ratings 36 want to read 2 currently reading 0 have read this edition doesn t have a description yet can you add one publish date 1980 publisher rand mcnally college pub co language english pages 632

*industry breakdown for output based gdp singstat* - May 06 2022

web the singapore standard industrial classification ssic provides the basic framework for the classification of economic activities the singapore department of statistics dos has implemented ssic 2020 in the national accounts

**industrial market structure and economic performance** - Jul 20 2023

web innovation patents and their relation to market structure are explored overall this analysis seeks to identify attributes or variables that influence economic performance and to build theories about the links between these attributes and end performance tnm

*industrial market structure and economic performance jstor* - Oct 23 2023

web industrial market structure and economic performance reviewed by charles f phillips jr professor of economics

washington and lee university this volume written by frederic m scherer of the university of michigan is one of the best

studies of the industrial organization field to be published in many years

**economic structures institutions and economic performance** - Aug 09 2022

web feb 10 2017 economic structures determine the rate of structural learning affect institutional performance influence the distribution of income and establish the direction of political transitions thereby economic performance

**industrial market structure and economic performance ssrn** - Sep 22 2023

web nov 4 2009 abstract provides a systematic presentation of the economic field of industrial organization which is concerned with how productive activities are brought into harmony with the demand for goods and services through an organizing mechanism such as a free market and how variations and imperfections in the organizing mechanism

industrial market structure and economic performance - Aug 21 2023

web industrial market structure and economic performance by scherer f m frederic m publication date 1980 topics industrial organization economic theory industrial policy publisher chicago rand mcnally college pub co

**industrial market structure and economic performance** - Mar 16 2023

web covering industrial market structure conduct and performance this is the third edition of a textbook which gives attention to the theoretical conclusions empirical findings and

industrial market structure and economic performance - Apr 05 2022

web advertisingagreementsalcoaaluminumamerican economic reviewanalysisassetsaveragebasing pointbehaviorbusiness weekbuyerscapacitycapitalcartelcentceteris paribuschangeschaptercollusivecompaniescompetitionconcentrated *market structure and industrial performance relation of profit* - Mar 04 2022

web market structure has long been considered as a prime determinant of industrial performance firms in the search for profit restrict output raise price and earn supernormal profit if the market structure in which they find themselves permits

**scherer f m industrial market structure and economic performance** - Jun 07 2022

web scherer f m industrial market structure and economic performance chicago rand mcnally co 1970 xi 576 pp 13 00 sosnick 1972 american journal of

**what are the biggest industries in singapore worldatlas** - Jan 02 2022

web worldatlas what are the biggest industries in singapore oil trading is a leading industry in singapore officially known as the republic of singapore singapore is an island nation in southeast asia with a free market economy that is highly developed *industrial market structure and economic performance* - Dec 13 2022

web apr 1 1990 industrial market structure and economic performance 3rd edition by frederic m scherer author david ross author 5 0 4 ratings see all formats and editions hardcover 13 87 17 used from 2 34 1 collectible from 16 99 this text has been revised to reflect theoretical empirical and policy developments of the past decade

*industrial market structure and economic performance* - Jun 19 2023

web may 11 2010 industrial market structure and economic performance by f m scherer chicago rand mcnally co 1970 pp xi 576 13 00 the journal of economic history cambridge core

**singapore industrial production index growth 1984 ceic data** - Dec 01 2021

web jun 1 2018 singapore industrial production index growth 1984 2023 monthly ceic data

**chapter iii industrial market structure and conduct springer** - Nov 12 2022

web industrial market structure and conduct overview this chapter introduces the concepts of market structure conduct and performance it is this approach to the analysis of economic markets which particularly distinguishes industrial organisation studies from more formal microeconomics

**industrial market structure and economic performance** - Oct 11 2022

web industrial market structure and economic performance worldcat org 0 reviews authors f m scherer author david ross author summary this text has been revised to reflect theoretical empirical and policy developments of the past decade new insights into strategic behaviour from game theory are given attention

**industrial market structure and economic performance** - Jan 14 2023

web frederic m scherer david r ross houghton mifflin 1990 industrial organization economic theory 713 pages this text has been revised to reflect theoretical empirical and policy

**industrial market structure and economic performance** - Apr 17 2023

web industrial market structure and economic performance responsibility f m scherer david ross edition 3rd ed imprint boston houghton mifflin c1990 physical description xvi 713 p ill 25 cm at the library law library crown today s hours 8 30a 7p basement request more options find it at other libraries via worldcat

**industrial market structure and performance 1960 1968 the economic** - Sep 10 2022

web dec 1 1976 industrial market structure and performance 1960 1968 the economic journal oxford academic david burningham industrial market structure and performance 1960 1968 the economic journal volume 86 issue 344 1 december 1976 pages 917 918 do skip to main content advertisement journals books

**industrial market structure and economic performance** - Jul 08 2022

web industrial market structure and economic performance semantic scholar corpus id 154170910 industrial market structure and economic performance c f phillips published 1971 economics no paper link available save to library create alert cite 3 311 citations citation type more filters

**ekonomija seminarski radovi** - Jan 08 2023

web samo besplatni seminarski radovi seminarski rad bez placanja naknada sms a uslovljavanja proverite download

seminarski rad besplatno maturaški diplomski Ovo delo je licencirano pod uslovima licence

mojrad besplatni seminarski maturaški maturalni i diplomski radovi - Jun 01 2022

web mojrad besplatni seminarski maturaški maturalni i diplomski radovi besplatno preuzmite seminarski diplomski maturaški iz razlicitih oblasti seminarski maturaški download besplatno free radovi arheologija astronomija biologija ekologija ekonomija elektrotehnika energetika etnologija filozofija fizika gradjevinarstvo hemija

*besplatni seminarski i diplomski radovi* - May 12 2023

web isplata alertpay a za srbiju i hrvatsku gotovi seminarski maturaški maturalni i diplomski radovi seminarski rad diplomski master magistarski maturalni prevodjenje zaradite novac objavljivanjem svojih seminarskih maturaških

*besplatni seminarski radovi facebook* - Mar 30 2022

web besplatni seminarski radovi 1 696 likes besplatni seminarski radovi

**besplatni gotovi seminarski diplomski i maturaški rad yumpu** - Nov 06 2022

web besplatni gotovi seminarski diplomski i maturaški rad br radovi iz svih oblasti powerpoint prezentacije i drugi edukativni br materijali br www seminarskirad org br www magistarski com br www maturaški radovi net br www maturaški net br

**besplatni seminarski i diplomski radovi maturaški net** - Jan 28 2022

web besplatan download seminarskih radova besplatni seminarski i diplomski maturaški radovi i prezentacije razmena radova kvalitetni radovi magistarski seminarski rad

**besplatni seminarski i diplomski radovi** - Jul 14 2023

web besplatni seminarski i diplomski radovi fizika prikaži 510152050100sve početak prethodna12sledeća kraj strana 1 od 2 pretraga radova novo u čitaonici cheap dedicated servers fenixvps izrada novih radova deo pravila uplati mi dopunu nova vrsta sms prevare u srbiji internet marketing jeftino za vas sajt strani filmovi sa prevodom

*besplatni seminarski i diplomski radovi* - Apr 11 2023

web isplata alertpay a za srbiju i hrvatsku gotovi seminarski maturaški maturalni i diplomski radovi seminarski rad diplomski master magistarski maturalni prevodjenje zaradite novac objavljivanjem svojih seminarskih maturaških

**diplomski seminarski maturaški** - Aug 03 2022

web seminarski radovi 10 000 gotovih seminarskih tekstova i druge pomoćne literature automatski sadržaji fusnote popis slika tabele izrada prezentacija gotovi seminarski diplomski maturaški tekstovi maturaški tekstovi 2 izrada sajtova kako ovo je uobičajena reakcija velike većine

**besplatni seminarski i diplomski radovi seminarski maturaški** - Jun 13 2023

web isplata alertpay a za srbiju i hrvatsku gotovi seminarski maturaški maturalni i diplomski radovi seminarski rad diplomski master magistarski maturalni prevodjenje zaradite novac objavljivanjem svojih seminarskih maturaških

**seminarski rad you tube pdf scribd** - Jul 02 2022

web seminarski rad dijana filipovi 3 c fyoutube je popularni internetski servis za razmjenu video sadraja gdje korisnici mogu postavljati pregledavati i ocjenjivati video isjeke youtube com adresa je na kojoj se nalaze milijarde razliitih video zapisa iz svih dijelova svijeta postavljanih od strane registriranih youtube korisnika

**besplatniseminarski com besplatni seminarski maturalni izrada** - Aug 15 2023

web besplatniseminarski com samo besplatni seminarski radovi seminarski rad bez placanja naknada sms a uslovljavanja proverite

**seminarski diplomski maturalni izrada** - Sep 04 2022

web dobrodošli pre nešto više od 5 godina nastao je internet portal maturalni izrada net magistarski seminarski rad sa idejom da pomogne svim maturantima studentima diplomcima i apsolvantima da što kvalitetnije urade svoje samostalne radove

**besplatni gotovi seminarski diplomski i maturalni izrada** - Mar 10 2023

web u našoj bazi se nalaze gotovi seminarski diplomski i maturalni izrada 1 radovi koji možete skinuti i uz njihovu pomoc napraviti jedinstven i unikatan rad ako u bazi ne nadjete rad koji vam je potreban u svakom momentu mozete naruciti da se izradi novi unikatan seminarski ili neki drugi rad na linku novi radovi

**maturalni izrada besplatni diplomski master magistarski radovi** - Dec 07 2022

web besplatni seminarski radovi seminarski rad seminarski radovi download seminarski rad besplatno maturalni izrada diplomski gotovi besplatni diplomski radovi master rad bez placanja

**besplatniseminarski net besplatni seminarski maturalni izrada** - Feb 26 2022

web besplatniseminarski net samo besplatni seminarski radovi seminarski rad bez placanja naknada sms a uslovljavanja proverite materijali za električne kontakte i termoparove vrsta seminarski broj strana 8

**maturalni izrada net master magistarski seminarski maturalni izrada** - Oct 05 2022

web maturalni izrada seminarski diplomski radovi dobrodošli na najpoznatiji i najstariji internet portal koji se bavi maturalnim seminarskim i diplomskim radovima 7 godina tradicije su dokaz kvaliteta našeg rada i kvaliteta našeg tima zahvaljući tome smo postali apsolutni lider stekli ugled i prepoznatljivo ime

**besplatniseminarski com besplatni seminarski maturalni izrada** - Dec 27 2021

web samo besplatni seminarski radovi seminarski rad bez placanja naknada sms a uslovljavanja proverite download seminarski rad besplatno maturalni izrada diplomski maturalni Ovo дело je лиценцирано под условима лиценце

**seminarski diplomski maturalni izrada** - Apr 30 2022

web besplatan download seminarskih radova besplatni seminarski i diplomski maturalni izrada i prezentacije razmena radova kvalitetni radovi magistarski seminarski rad

*maturski net brezplačni seminarji maturski diplomski maturalski - Feb 09 2023*

web maturski org samo brezplačni seminarji radovi seminarji rad bez placanja naknada sms a uslovljavanja proverite