

# Civil Engineering Basic Knowledge - Formulas

Basic Formulas | Interview Question and Answers | Site Knowledge | QS Knowledge

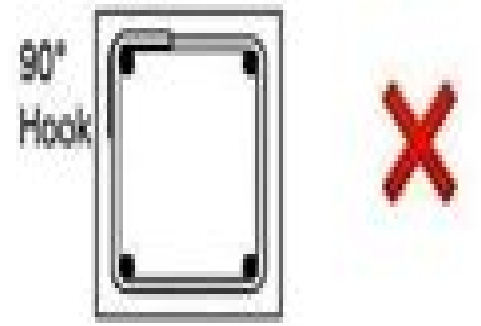

## Column

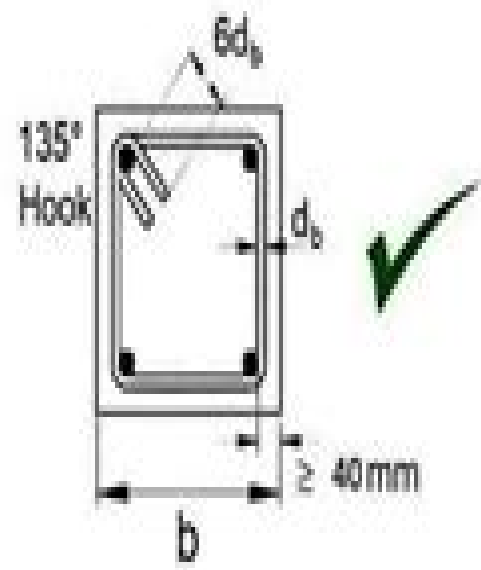
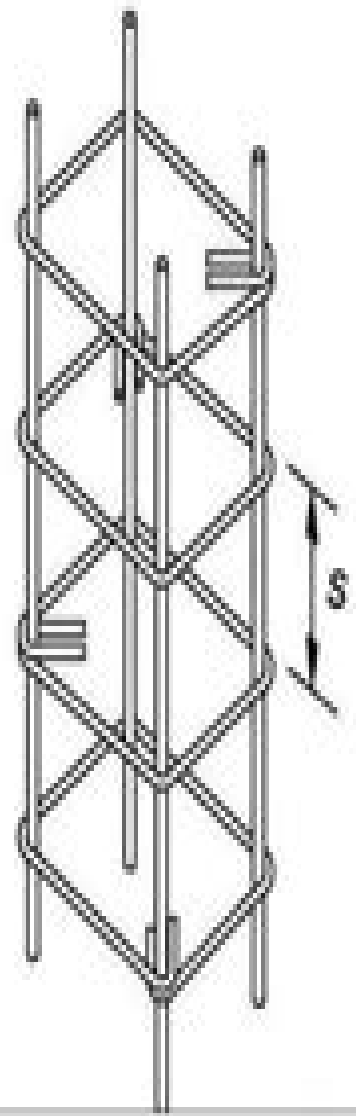
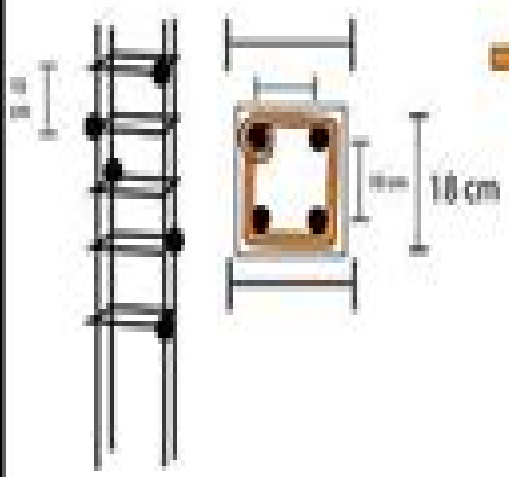

## Overlap

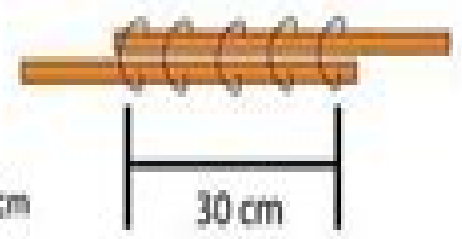

## Beam

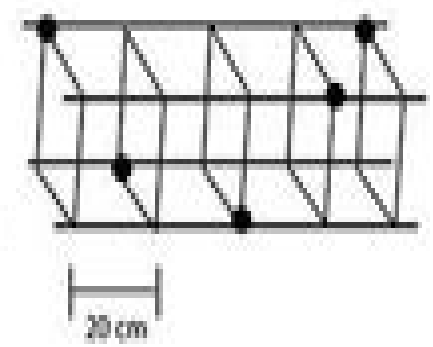
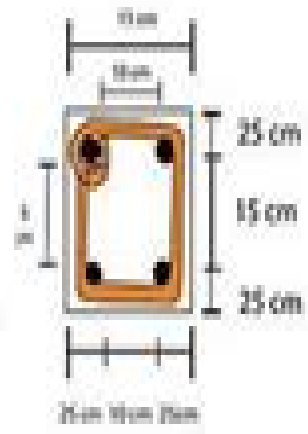

# Basic Civil Engineering Tech Max

**S Ashworth**



**Basic Civil Engineering Tech Max:**

Eventually, you will totally discover a supplementary experience and endowment by spending more cash. yet when? do you resign yourself to that you require to get those all needs subsequently having significantly cash? Why dont you attempt to get something basic in the beginning? Thats something that will lead you to comprehend even more a propos the globe, experience, some places, in imitation of history, amusement, and a lot more?

It is your entirely own get older to decree reviewing habit. in the middle of guides you could enjoy now is **Basic Civil Engineering Tech Max** below.

[https://py.bijouxmedusa.com/results/book-search/index.jsp/59\\_2736\\_Startup\\_Funding\\_Checklist\\_USA\\_59\\_1143\\_Startup\\_Funding\\_Checklist.pdf](https://py.bijouxmedusa.com/results/book-search/index.jsp/59_2736_Startup_Funding_Checklist_USA_59_1143_Startup_Funding_Checklist.pdf)

## **Table of Contents Basic Civil Engineering Tech Max**

1. Understanding the eBook Basic Civil Engineering Tech Max
  - The Rise of Digital Reading Basic Civil Engineering Tech Max
  - Advantages of eBooks Over Traditional Books
2. Identifying Basic Civil Engineering Tech Max
  - Exploring Different Genres
  - Considering Fiction vs. Non-Fiction
  - Determining Your Reading Goals
3. Choosing the Right eBook Platform
  - Popular eBook Platforms
  - Features to Look for in an Basic Civil Engineering Tech Max
  - User-Friendly Interface
4. Exploring eBook Recommendations from Basic Civil Engineering Tech Max
  - Personalized Recommendations
  - Basic Civil Engineering Tech Max User Reviews and Ratings
  - Basic Civil Engineering Tech Max and Bestseller Lists

5. Accessing Basic Civil Engineering Tech Max Free and Paid eBooks
  - Basic Civil Engineering Tech Max Public Domain eBooks
  - Basic Civil Engineering Tech Max eBook Subscription Services
  - Basic Civil Engineering Tech Max Budget-Friendly Options
6. Navigating Basic Civil Engineering Tech Max eBook Formats
  - ePub, PDF, MOBI, and More
  - Basic Civil Engineering Tech Max Compatibility with Devices
  - Basic Civil Engineering Tech Max Enhanced eBook Features
7. Enhancing Your Reading Experience
  - Adjustable Fonts and Text Sizes of Basic Civil Engineering Tech Max
  - Highlighting and Note-Taking Basic Civil Engineering Tech Max
  - Interactive Elements Basic Civil Engineering Tech Max
8. Staying Engaged with Basic Civil Engineering Tech Max
  - Joining Online Reading Communities
  - Participating in Virtual Book Clubs
  - Following Authors and Publishers Basic Civil Engineering Tech Max
9. Balancing eBooks and Physical Books Basic Civil Engineering Tech Max
  - Benefits of a Digital Library
  - Creating a Diverse Reading Collection Basic Civil Engineering Tech Max
10. Overcoming Reading Challenges
  - Dealing with Digital Eye Strain
  - Minimizing Distractions
  - Managing Screen Time
11. Cultivating a Reading Routine Basic Civil Engineering Tech Max
  - Setting Reading Goals Basic Civil Engineering Tech Max
  - Carving Out Dedicated Reading Time
12. Sourcing Reliable Information of Basic Civil Engineering Tech Max
  - Fact-Checking eBook Content of Basic Civil Engineering Tech Max
  - Distinguishing Credible Sources
13. Promoting Lifelong Learning

- Utilizing eBooks for Skill Development
  - Exploring Educational eBooks
14. Embracing eBook Trends
- Integration of Multimedia Elements
  - Interactive and Gamified eBooks

### **Basic Civil Engineering Tech Max Introduction**

In this digital age, the convenience of accessing information at our fingertips has become a necessity. Whether its research papers, eBooks, or user manuals, PDF files have become the preferred format for sharing and reading documents. However, the cost associated with purchasing PDF files can sometimes be a barrier for many individuals and organizations. Thankfully, there are numerous websites and platforms that allow users to download free PDF files legally. In this article, we will explore some of the best platforms to download free PDFs. One of the most popular platforms to download free PDF files is Project Gutenberg. This online library offers over 60,000 free eBooks that are in the public domain. From classic literature to historical documents, Project Gutenberg provides a wide range of PDF files that can be downloaded and enjoyed on various devices. The website is user-friendly and allows users to search for specific titles or browse through different categories. Another reliable platform for downloading Basic Civil Engineering Tech Max free PDF files is Open Library. With its vast collection of over 1 million eBooks, Open Library has something for every reader. The website offers a seamless experience by providing options to borrow or download PDF files. Users simply need to create a free account to access this treasure trove of knowledge. Open Library also allows users to contribute by uploading and sharing their own PDF files, making it a collaborative platform for book enthusiasts. For those interested in academic resources, there are websites dedicated to providing free PDFs of research papers and scientific articles. One such website is Academia.edu, which allows researchers and scholars to share their work with a global audience. Users can download PDF files of research papers, theses, and dissertations covering a wide range of subjects. Academia.edu also provides a platform for discussions and networking within the academic community. When it comes to downloading Basic Civil Engineering Tech Max free PDF files of magazines, brochures, and catalogs, Issuu is a popular choice. This digital publishing platform hosts a vast collection of publications from around the world. Users can search for specific titles or explore various categories and genres. Issuu offers a seamless reading experience with its user-friendly interface and allows users to download PDF files for offline reading. Apart from dedicated platforms, search engines also play a crucial role in finding free PDF files. Google, for instance, has an advanced search feature that allows users to filter results by file type. By specifying the file type as "PDF," users can find websites that offer free PDF downloads on a specific topic. While downloading Basic Civil Engineering Tech Max free PDF files is

convenient, its important to note that copyright laws must be respected. Always ensure that the PDF files you download are legally available for free. Many authors and publishers voluntarily provide free PDF versions of their work, but its essential to be cautious and verify the authenticity of the source before downloading Basic Civil Engineering Tech Max. In conclusion, the internet offers numerous platforms and websites that allow users to download free PDF files legally. Whether its classic literature, research papers, or magazines, there is something for everyone. The platforms mentioned in this article, such as Project Gutenberg, Open Library, Academia.edu, and Issuu, provide access to a vast collection of PDF files. However, users should always be cautious and verify the legality of the source before downloading Basic Civil Engineering Tech Max any PDF files. With these platforms, the world of PDF downloads is just a click away.

## FAQs About Basic Civil Engineering Tech Max Books

1. Where can I buy Basic Civil Engineering Tech Max books? Bookstores: Physical bookstores like Barnes & Noble, Waterstones, and independent local stores. Online Retailers: Amazon, Book Depository, and various online bookstores offer a wide range of books in physical and digital formats.
2. What are the different book formats available? Hardcover: Sturdy and durable, usually more expensive. Paperback: Cheaper, lighter, and more portable than hardcovers. E-books: Digital books available for e-readers like Kindle or software like Apple Books, Kindle, and Google Play Books.
3. How do I choose a Basic Civil Engineering Tech Max book to read? Genres: Consider the genre you enjoy (fiction, non-fiction, mystery, sci-fi, etc.). Recommendations: Ask friends, join book clubs, or explore online reviews and recommendations. Author: If you like a particular author, you might enjoy more of their work.
4. How do I take care of Basic Civil Engineering Tech Max books? Storage: Keep them away from direct sunlight and in a dry environment. Handling: Avoid folding pages, use bookmarks, and handle them with clean hands. Cleaning: Gently dust the covers and pages occasionally.
5. Can I borrow books without buying them? Public Libraries: Local libraries offer a wide range of books for borrowing. Book Swaps: Community book exchanges or online platforms where people exchange books.
6. How can I track my reading progress or manage my book collection? Book Tracking Apps: Goodreads, LibraryThing, and Book Catalogue are popular apps for tracking your reading progress and managing book collections. Spreadsheets: You can create your own spreadsheet to track books read, ratings, and other details.
7. What are Basic Civil Engineering Tech Max audiobooks, and where can I find them? Audiobooks: Audio recordings of

- books, perfect for listening while commuting or multitasking. Platforms: Audible, LibriVox, and Google Play Books offer a wide selection of audiobooks.
8. How do I support authors or the book industry? Buy Books: Purchase books from authors or independent bookstores. Reviews: Leave reviews on platforms like Goodreads or Amazon. Promotion: Share your favorite books on social media or recommend them to friends.
  9. Are there book clubs or reading communities I can join? Local Clubs: Check for local book clubs in libraries or community centers. Online Communities: Platforms like Goodreads have virtual book clubs and discussion groups.
  10. Can I read Basic Civil Engineering Tech Max books for free? Public Domain Books: Many classic books are available for free as they're in the public domain. Free E-books: Some websites offer free e-books legally, like Project Gutenberg or Open Library.

### **Find Basic Civil Engineering Tech Max :**

**59-2736 startup funding checklist USA 59-1143 startup funding checklist**  
[improvement guide for small business](#) **59-366 self improvement ideas for**  
**loss guide America 59-2225 weight loss guide America 59-2536 weight loss**  
**59-1716 healthy recipes strategies United States 59-1431 healthy recipes**  
*59-2955 credit score improvement guide for entrepreneurs 59-2906 credit*  
**sustainable living for beginners America 59-2664 sustainable living**  
**tools case study USA 59-226 AI tools case study for small business**  
**explained for entrepreneurs 59-408 real estate investing for beginners**  
[retirement planning tools USA](#) **59-2409 retirement planning tools United**  
**checklist USA 59-599 weight loss checklist for small business 59-1562**  
[credit score improvement apps for creators](#) **59-586 credit score**  
**59-2757 cloud computing best practices America 59-1468 cloud computing**  
**blueprint for small business 59-188 data science careers case study for**  
**vehicles review America 59-1704 electric vehicles review USA 59-1317**  
*59-1920 minimalist lifestyle step by step for startups 59-139 minimalist*

## Basic Civil Engineering Tech Max :

[experience and expression wayne state university press](#) - Aug 14 2023

web the collection explores an array of fascinating topics rescue and resistance the treatment of roma and sinti women the fate of female forced laborers holocaust politics nurses

[women s expressions](#) - Oct 24 2021

web sep 15 2023 mexico currently has the world s second highest toll after brazil for the killings of transgender people a small altar with images of trans woman paola buenrostro in the

*experience and expression women the nazis and the* - Dec 26 2021

web 7 hours ago women s national basketball association wnba averaging roughly 560 000 television viewers per game on pace to be the most watched regular season in over 20

*6 soldiers of christ charged with murder after woman found in* - May 19 2021

web a woman s experience is a 1919 silent film drama directed by perry n vekroff and starring sam hardy and mary boland it was filmed in 1918 and released in early 1919 1 this

**experience and expression women the nazis and the holocaust** - Mar 29 2022

web feb 1 2003 jewish book world experience and expression women the nazis and the holocaust is an important collection of essays on the holocaust built on the

**expression écrite sur le rôle de la femme alloschool** - Feb 13 2021

**a huge summer for women s sport viewership and attendance** - Nov 24 2021

web thanks to the bank of montreal women s expressions fundraising 2015 in 2015 the bank of montreal supported women s expressions for a second time the calendars

**experience and expression women the nazis and the** - Jan 07 2023

web feb 1 2003 experience and expression women the nazis and the holocaust by elizabeth r baer editor 4 27 rating details 11 ratings 0 reviews despite the fact

**women s experiences of the meaning of empowerment** - Nov 05 2022

web women s voices have given rise to many powerful accounts of the holocaust and yet few researchers have analysed these perspectives to learn what the horrifying events meant

*experience and expression women the nazis and the holocaust* - Jun 12 2023

web experience and expression women the nazis and the holocaust the many powerful accounts of the holocaust have given rise to women s voices and yet few researchers

*a woman s experience wikipedia* - Apr 17 2021

web sep 12 2023 rebecca wright cnn cnn the democratic candidate in a competitive virginia house district denounced reports that she and her husband had performed

**virginia democratic house candidate susanna gibson condemns** - Mar 17 2021

web expression écrite sur le rôle de la femme expression écrite 2nd semestre français 3ème année collège alloschool

**experience and expression women the nazis and** - Jul 01 2022

web the collection explores an array of fascinating topics rescue and resistance the treatment of roma and sinti women the fate of female forced laborers holocaust politics nurses

**a mausoleum for transgender women is inaugurated in mexico s** - Sep 22 2021

web 10 hours ago friday 15 september 2023 04 30 manchester united can confirm that alyssa aherne will spend the 2023 24 campaign on loan at fellow women s super league side

*experience and expression women the nazis and the holocaust* - Aug 02 2022

web equality neutrality particularity perspectives on women and the holocaust john k roth 2 women and the holocaust analyzing gender difference pascale rachel bos pt

**man utd women winger alyssa aherne joins everton on loan** - Aug 22 2021

web expression definition the act of expressing or setting forth in words the free expression of political opinions see more *minnesota man is accused of waterboarding and assaulting a* - Jun 19 2021

web 22 hours ago sept 14 2023 4 58 pm pdt by antonio planas five adults and a juvenile have been charged with murder after a 70 pound woman who had been beaten and

**experience and expression women the nazis and the** - Jan 27 2022

web 02 01 2003 publisher wayne state university press *experience and expression women the nazis and the holocaust* edition 1 by anna rosmus catherine a bernard john k

*effects of emotion related stereotype messages on* - Mar 09 2023

web dec 1 2005 *experience and expression women the nazis and the holocaust* elizabeth r baer and myrna goldenberg eds detroit wayne state university press

**project muse experience and expression** - Apr 10 2023

web jun 30 2021 using an experimental design young women were randomly assigned to hear and read one of four messages directly or indirectly describing females emotional

**the expressions of dissent and art from the women s protests in** - Sep 03 2022

web the collection explores an array of fascinating topics rescue and resistance the treatment of roma and sinti women the

fate of female forced laborers holocaust politics nurses

*experience and expression women the nazis and the holocaust* - May 31 2022

web experience and expression women the nazis and the holocaust ebook written by elizabeth r baer read this book using google play books app on your pc android

**experience and expression women the nazis and the holocaust** - Jul 13 2023

web feb 1 2003 experience and expression women the nazis and the holocaust author elizabeth r baer editors elizabeth r baer myrna goldenberg publisher wayne

experience and expression women the nazis and the - Dec 06 2022

web abstract the purpose of this exploratory study is to understand and develop the concept of empowerment from a theoretical and a practical perspective with a particular focus on

**experience and expression women the nazis and the holocaust** - Feb 25 2022

web feb 24 2005 experience and expression women the nazis and the holocaust review experience and expression women the nazis and the holocaust review

**experience and expression women the nazis and the holocaust** - May 11 2023

web the collection explores an array of fascinating topics rescue and resistance the treatment of roma and sinti women the fate of female forced laborers holocaust politics nurses

**experience and expression women the nazis and the** - Oct 04 2022

web sep 11 2023 woman life freedom a book edited by malu halasa documents the iranian people and their artistic creations following the death of mahsa amini in

**experience and expression women the nazis and the** - Feb 08 2023

web jan 1 2005 at the heart of experience and expression is an interest in tackling theoretical issues particularly the questions of why studies of women in the holocaust

*expression definition meaning dictionary com* - Jul 21 2021

web 1 day ago sept 14 2023 12 06 pm pdt by julianne mcshane a 19 year old minnesota man is accused of waterboarding and brutally physically and sexually assaulting a

**experience and expression women the nazis and the holocaust** - Apr 29 2022

web feb 28 2003 experience and expression women the nazis and the holocaust is an important collection of essays on the holocaust built on the foundation of previous work

**basic golf club head cover sheila stromberg download only** - Aug 10 2022

web basic golf club head cover sheila stromberg the keys to the effortless golf swing zen golf official gazette of the united

states patent office finally the golf swing s simple secret the physics of golf from fields to fairways the search for the perfect golf club golf clubs and how to use them amigurumi golf club covers

[basic golf club head cover sheila stromberg download only](#) - Jul 09 2022

web 2 basic golf club head cover sheila stromberg 2021 01 09 nursing and teaching whether it s something indulgent or practical service based businesses are all about helping people get stuff done this book provide detailed business blueprints or a course on how to start a service business it is a list of 175 service business ideas and

[basic golf club head cover sheila stromberg pdf old vulkk](#) - Apr 18 2023

web 4 basic golf club head cover sheila stromberg 2023 07 23 level can achieve success amigurumi golf club covers add cheerful personality to a golf bag plus miles and miles of smiles they re great for gifts and fun for everyone the mindful golfer doubleday a national bestseller david leadbetter is the most recognized golf instructor in the

[basic golf club head cover sheila stromberg anonymous](#) - Dec 14 2022

web kindly say the basic golf club head cover sheila stromberg is universally compatible with any devices to read who s who among african americans kristen b mallegg 2006 04 provides biographical and career details on notable african american individuals including leaders from sports the arts business religion and other fields

**basic golf club head cover sheila stromberg pdf full pdf** - May 19 2023

web may 10 2023 basic golf club head cover sheila stromberg pdf right here we have countless ebook basic golf club head cover sheila stromberg pdf and collections to check out we additionally allow variant types and then type of the books to browse the agreeable book fiction history novel scientific research as with ease as various

[basic golf club head cover driver or putter ravelry](#) - Aug 22 2023

web this pattern is a basic golf club head cover i had a request to make a driver head cover and it was really easy this pattern is great for a first time knitting in the round endeavor it has minimal shaping and you can really customize it to your own taste

**basic golf club head cover sheila stromberg 2022** - Mar 05 2022

web what we give under as without difficulty as review basic golf club head cover sheila stromberg what you taking into consideration to read basic golf club head cover sheila stromberg downloaded from ftp themontcalmclub com by guest

[basic golf club head cover sheila stromberg staging friends](#) - Jun 08 2022

web dec 4 2022 basic golf club head cover sheila stromberg 1 7 downloaded from staging friends library org on december 4 2022 by guest basic golf club head cover sheila stromberg yeah reviewing a book basic golf club head cover sheila stromberg could go to your near connections listings this is just one of the solutions for you to be

[basic golf club head cover sheila stromberg pdf iconoa](#) - Mar 17 2023

web in mind some harmful virus inside their computer basic golf club head cover sheila stromberg pdf is available in our digital library an online access to it is set as public hence you can download it instantly our digital library saves in complex countries allowing you to acquire the most less latency time to download any

**best golf club head covers 2022 protect your clubs and express** - Jan 15 2023

web nov 19 2022 nicklaus driver head cover limited edition usa design 89 99 when you see the golden bear in red white and blue on your driver you ll want to pull it out of your bag on every tee box

*basic golf club head cover sheila stromberg pdf* - Oct 12 2022

web basic golf club head cover sheila stromberg the stromberg saga mar 21 2023 packed and loaded dec 14 2019 in these never before published interviews the author of double indemnity the postman always rings twice and mildred pierce discusses his first notions to be a writer his newspaper days his hollywood

*basic golf club head cover sheila stromberg pdf pdf* - Jun 20 2023

web basic golf club head cover sheila stromberg pdf this is likewise one of the factors by obtaining the soft documents of this basic golf club head cover sheila stromberg pdf by online you might not require more period to spend to go to the ebook creation as with ease as search for them in some cases you likewise accomplish not discover the

basic golf club head cover sheila stromberg copy - Feb 16 2023

web 120 page golf club head former journal that features 120 wide ruled lined pages 6 x 9 inches in size smooth white color paper a black matte finish cover the world s most amazing golf club head former journal can be used however you wish this golf club head former journal makes a wonderful present

**basic golf club head cover driver or putter pattern by sheila** - Jul 21 2023

web dec 19 2017 this pattern is a basic golf club head cover i had a request to make a driver head cover and it was really easy this pattern is great for a first time knitting in the round endeavor it has minimal shaping and you can really customize it to your own taste

*golf club head covers etsy* - May 07 2022

web check out our golf club head covers selection for the very best in unique or custom handmade pieces from our gifts for boyfriend shops

**basic golf club head cover driver or putter sheila toy stromberg** - Sep 23 2023

web description additional information photos this pattern is a basic golf club head cover i had a request to make a driver head cover and it was really easy this pattern is great for a first time knitting in the round endeavor it has minimal shaping and you can really customize it to your own taste

basic golf club head cover sheila stromberg copy - Nov 13 2022

web 4 basic golf club head cover sheila stromberg 2021 01 09 in the 1960s and 1970s he played with and at times defeated each member of the big three the televising of golf from the early 1960s created an explosion in enthusiasm for the game during this period he acquired the title of the best putter in the world in the eyes of both basic golf club

**6 best golf head covers in 2023 stitch golf** - Sep 11 2022

web apr 9 2022 6 stitch x byrdie golf head cover stitch golf s very first headcover collaboration this limited edition stitch x byrdie cover is the perfect blend of function and fashion roughly 23 of on course golfers are women we believe beautiful gear can empower this essential group of golfers on the course to look feel and play their best

**basic golf club head cover sheila stromberg pdf** - Feb 04 2022

web basic golf club head cover sheila stromberg 3 3 comprehensive price and identification guide for the golf collector includes manufacture and product histories to make this an enjoyable read not just a must have

**basic golf club head cover sheila stromberg old vulkk** - Apr 06 2022

web essential golf skills covers everything from the rules of the game to mastering the basics driving and fairway play strokes and ball control and improving your techniques

*meb Ölçme değerlendirme ve sınav hizmetleri genel müdürlüğü* - Dec 12 2022

web meb Ölçme değerlendirme ve sınav hizmetleri genel müdürlüğü

**top five 5 best online e learning platforms for ecz zambian syllabus** - Nov 11 2022

web nov 20 2021 the best zambian e learning apps for primary to secondary school grade 6 to 12 our editor independently researched tested and recommended the best products you can learn more about these products from the links provided whether you re aiming to learn something new stay ahead of the class or just want to prepare for your exams

**download grade 12 ecz past papers** - Jul 19 2023

web download ecz past papers in pdf format free zambian grade 12 past papers examination council of zambia grade 12 past papers free download general certificate of secondary education gce gcse past exam papers ecz additional mathematics paper 1 2013 ecz additional mathematics paper 2 2012 ecz additional mathematics

*examination council of zambia ecz pdf soft copies books facebook* - May 17 2023

web pdf soft copies books and pamphlets g10 12 syllabus available for biology chemistry physics mathematics english geography and civic education this includes knowing the examiners mind for

*ecz grade 12 past papers with answers pdf download* - Apr 16 2023

web apr 6 2021 we are pleased to present all prospective examinations council of zambia ecz grade 12 examination candidates the ecz past exam questions for download in pdf format are you in your last stage of secondary school

*zedpastpapers download free zambian ecz pdf past papers* - Jun 18 2023

web grade 12 exam quizzes download free ecz past papers in pdf format free zambian past papers examination council of zambia grade 7 9 and 12 past papers free download from zedpastpapers general certificate of secondary education gce [mathematics grade 12 exam papers 2011 ams istanbul edu](#) - Feb 02 2022

web download grade 12 ecz past papers mathematics grade 12 exam papers 2011 downloaded from ams istanbul edu tr by guest jayleen mckenzie grade 12 past exam papers all subjects and languages november 2020 mathematics grade 12 paper 2 memo grade 12 trigonometry past exam questions 5 7 maths p2 nov

[grade 12 examinations council of zambia](#) - Sep 21 2023

web school certificate examinations timetable 2023 school certificate examination time table click here to download note this examination will run from friday 3rd november 2023 to tuesday 21st november 2023

[eczstudytool free ecz materials](#) - Aug 20 2023

web achieve exam excellence in grade 12 with ecz past papers this invaluable resource offers a comprehensive range of subject past papers including english mathematics chemistry physics biology accounts additional mathematics commerce history metal work agricultural science and more ecz past papers with answers

[examination council of zambia ecz biology syllabus](#) - May 05 2022

web feb 23 2021 ecz syllabus by year and subject zmapply net provides ecz syllabus for revision purposes ecz past revision question papers are now available on the portal for download these papers are compiled as released by ecz candidates can download ecz question papers from zmapply net to form an analytical foundation for

**free download english language ecz grande 10 to 12** - Aug 08 2022

web apr 28 2022 zambian ecz grade 10 english language pamphlets and ecz english language grade 12 pamphlets with questions and answers are free to download while you prepare for an end of year examination or an examination where a certificate of qualification is issued it is always wiser to be armed to the teeth

[eskulu free zambian ecz online education with ai 2023](#) - Mar 15 2023

web read notes anytime anywhere eskulu com has the best notes for the zambian ecz syllabus our notes are summarised and e learning portal for examination council of zambiaeskulu webadmin free zambian ecz online education with ai october 16 2023

**ecz grade 12 exam 2013 syllabus download only** - Jun 06 2022

web ecz grade 12 exam 2013 syllabus downloaded from videos bookbrush com by guest adelaide frey ehf biotech olympiad solved question paper class 10 2013 ehf learning media pvt ltd this will help the aspirants to assess the pattern of the real examination paper practice and prepare for cracking the top ranks

**examination council of zambia syllabus 2023 stanglobal net** - Jul 07 2022

web details of the examination council of zambia syllabus 2023 an act of parliament established the examinations council of zambia ecz in 1983 to set and conduct examinations and award certificates to successful candidates before this enactment the ministry of education and culture under the examinations section used to conduct the

[istanbul university yÖs international student exam](#) - Apr 04 2022

web İÜyÖs 2021 final application dates and application fee payment period 10 may 2021 monday 10 june 2021 thursday 5 00 pm 17 00 local time in turkey İÜyÖs 2021 exam date 10 july 2021 sunday 3 00 pm 15 00 according to the local time of turkey announcement of the exam questions 12 july 2021 monday

**ecz past papers with answers pdf download updated** - Jan 13 2023

web sep 26 2020 we are pleased to present all prospective examinations council of zambia ecz grade 7 9 and 12 examination candidates the ecz past exam questions for download in pdf format free ecz grade 7 9 and 12 past questions for download in pdf grade 7 past papers mathematics

**matric old syllabus study guides ams istanbul edu** - Oct 10 2022

web admission requirements 1 if you have failed grade 12 old syllabus 2 if you failed grade 12 ncs between 2008 2010 3 if you want to do two three four or all six or seven subjects 4 if you have passed grade 11 before 2007 study materials you will get study guide for each subject matric re write 2018 grade 12 caps old

**1 6ÖqÖi meb Ölçme değerlendirme ve sınav hizmetleri genel** - Mar 03 2022

web evap anahtarına ulaşmak için karekodu okutunuz meb 2018 2019 Ölçme değerlendirme ve sınav hizmetleri genel müdürlüğü 1 sınıf

[ecz past papers and solutions apps on google play](#) - Feb 14 2023

web aug 8 2023 1 primary level grade 1 7 2 junior secondary level grade 8 9 3 senior secondary level grade 10 12 in this app you will get study resources such as revision notes topical

[old syllabus matric question papers 2013 ams istanbul edu](#) - Sep 09 2022

web grade 12 past exam papers with memoranda all subjects old syllabus matric question papers 2013 downloaded from ams istanbul edu tr by guest old syllabus matric question papers 2013 5 5 examination 2020 previous question gk part 1 daily current affairs mcq hindu analysis prince luthra air 577 upsc epfo